

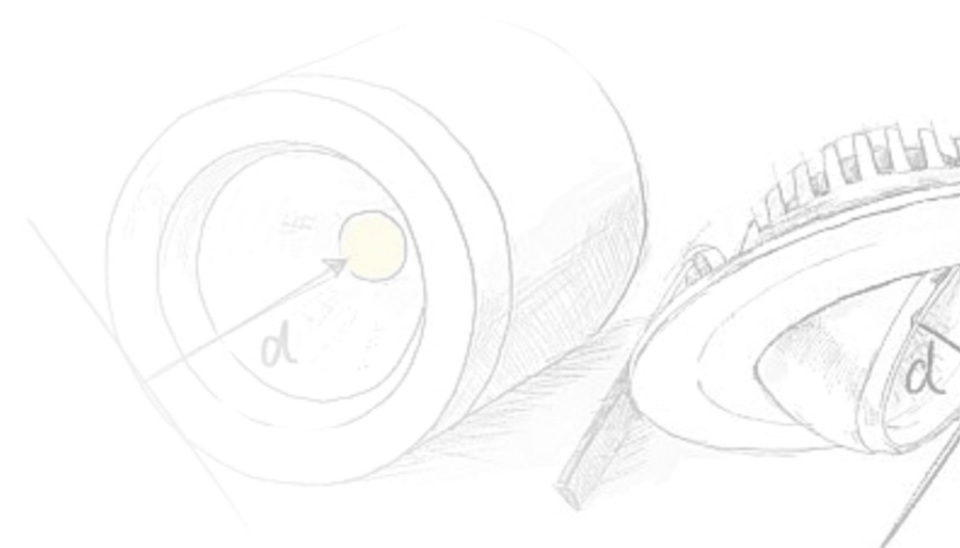

[www.leader-light.com](http://www.leader-light.com)



雷德照明科技(广东)有限公司  
Leader Lighting Co., Ltd.

Add: No. 16 Jun Ye Bei Road, Zone C, Shishan Technology & Industry Garden, Nanhai District, Foshan City, Guangdong Province, China

Tel: +86-757-81208219

Fax: +86-757-81208217

E-mail: [leaderlight@126.com](mailto:leaderlight@126.com) Website: [www.leader-light.com](http://www.leader-light.com)

# LEADER LIGHTING

SUPERMARKET 专注商超照明  
LIGHTS



雷德照明科技(广东)有限公司成立于2005年8月,至今已有17年多的历史。经过多年的持续发展,公司已建立健全了一套现代企业管理制度。

在产品研发领域:有着超强和稳定的产品研发队伍,现有研发人员十多人;新产品研发周期短,性能优,成本低,研发成功率高。

公司在品质控制领域:用先进的管控手段对产品过程进行监控,有一套完善的质量保证体系,并于2010年取得BSCI国际规范管理认证,2012年取得ISO 9001:2008质量管理体系认证,2017年升版为ISO 9001:2015,2013年获国家安监总局安全生产标准化认证,2016年获得国家高新技术企业证书,2018年获得南海区工程技术研究中心;公司从2008年较早在国内对LED光源实施应用,经过多年的积累、掌握LED产品特性,在国际国内取得较大市场份额。因此公司也建立了LED产品的一整套控制、检测、实验流程,控制产品质量。

雷德照明科技(广东)有限公司专业生产中高端商超LED照明产品,产品全部采用进口的专业用于工程项目研发的LED芯片,具有寿命长、光衰小、超节能等特点。公司定位服务于各大类型商超百货项目的室内照明。

Add:No.16 Jun Ye Bei Road, Zone C, Shishan Technology & Industry Garden, Nanhai District, Foshan City, Guangdong Province, China

Tel:+86-757-81208219

Fax:+86-757-81208217

E-mail:leaderlight@126.com

Website:www.leader-light.com

关于我们

## ABOUT US

**WE MAKE  
LIGHT \_\_\_\_\_  
THAT MAKES YOU SEE  
LIGHT \_\_\_\_\_  
LIGHT ART**

Leader Lighting Co., Ltd. was established in August of 2005, which already has over 17 years history until now. After many years of sustained development, the company has established a modern enterprise management system. In product development field: The company has a strong and stable product development team, which has more than a dozen development staffs; the new products are developed in a short cycle, with perfect function, low cost, and high success rate.

In quality control field: the company uses advanced control means to monitor the product process, has a set of perfect quality assurance system, and obtained BSCI international standard management certification in 2010, ISO 9001:2008 quality management system certification in 2012 and upgraded version to ISO 9001:2015 in 2017, national safety production standardization certification in 2013, national high-tech enterprise certificate in 2016, and Nanhai Engineering Technology Research Center in 2018. The company has applied led light source in China since 2008. After many years of accumulation, it has mastered the characteristics of led products and obtained a large market share at home and abroad. Therefore, the company has also established a set of led product control, testing, experimental process, control product quality.

Leader Lighting Co., Ltd. specializes in the production of high-end commercial supermarket led lighting products, all products use imported led chips which are specially used for engineering project research and development, the products have the characteristics of long life, small light decay, super energy saving and so on. The company serves the indoor lighting of various types of commercial supermarket and convenient stores.

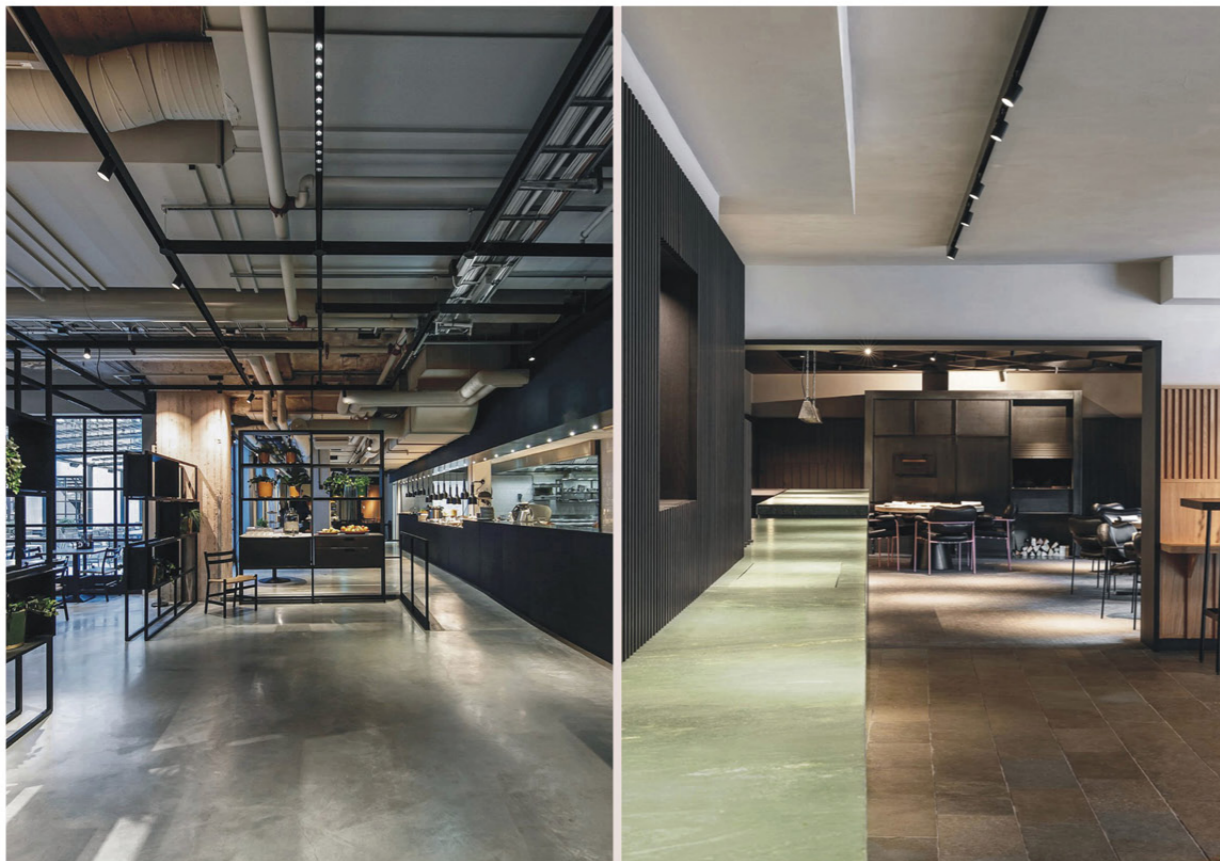

## INDEX | 产品索引

---

48V 超薄磁轨道灯系列  
48V Ultra-thin magnetic track light series P001-018

---

220V 磁轨道灯系列  
220V Magnetic track light series P019-030

---

超市货架灯系列  
Supermarket shelf lights series P031-040

---

超薄明装灯系列  
Ultra thin surface mounted lamp series P041-042

---

轨道射灯系列  
Track spotlights series P043-048

---

明装筒灯系列  
Mounted downlight series P049-050

---

嵌入式筒灯系列  
Embedded downlight series P051-060

---

象鼻灯系列  
Trunk light series P061-062

---

线条灯系列  
Line light series P063-068

---

## LD-20系列

### 超薄明装磁吸导轨条

### Ultra thin surface mounted magnetic guide rail

型号/Model	尺寸/Size	材质/Material	颜色/Color
LD-C02110	1000x20x5.5mm	铝材/Aluminum	砂白、砂黑/White, Black
LD-C02120	2000x20x5.5mm	铝材/Aluminum	砂白、砂黑/White, Black
LD-C02130	3000x20x5.5mm	铝材/Aluminum	砂白、砂黑/White, Black

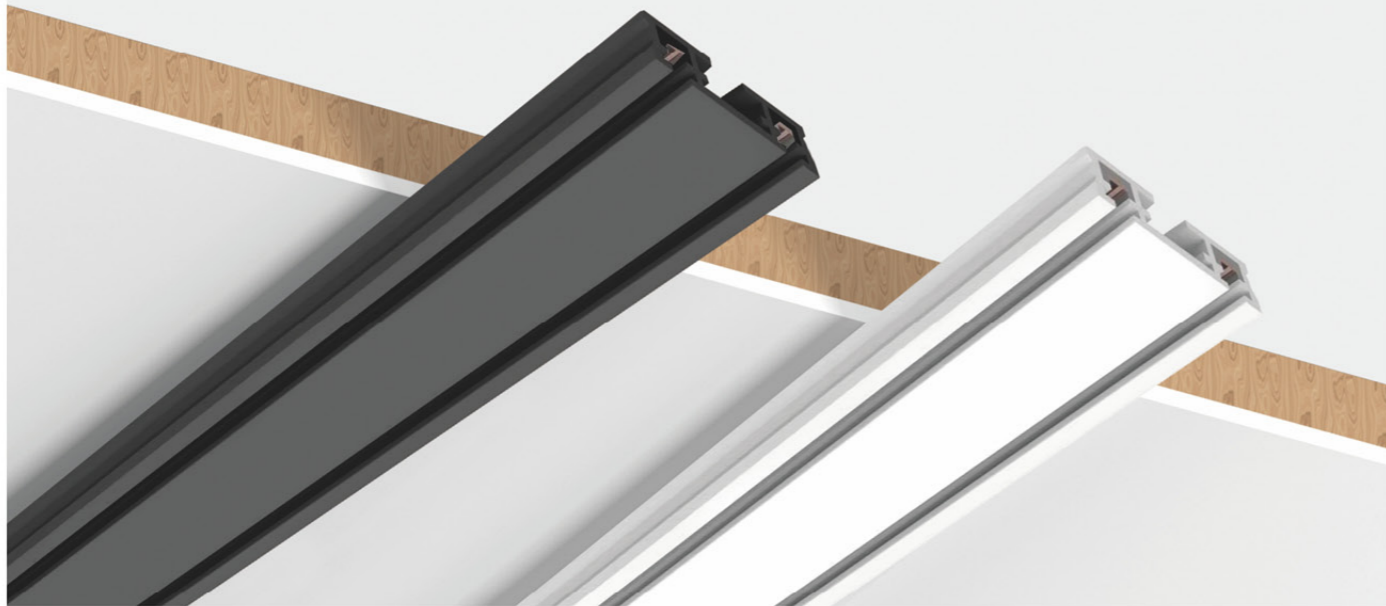

## 5.5mm厚度 5.5 mm thin thickness

对于厚度仅为5.5毫米的薄磁轨道，超薄线条设计创造极简主义的空间美  
To a thin magnetic orbit with a thickness of only 5.5mm, Ultra-thin line design creates minimalist space beauty

### 超薄设计 5.5mm

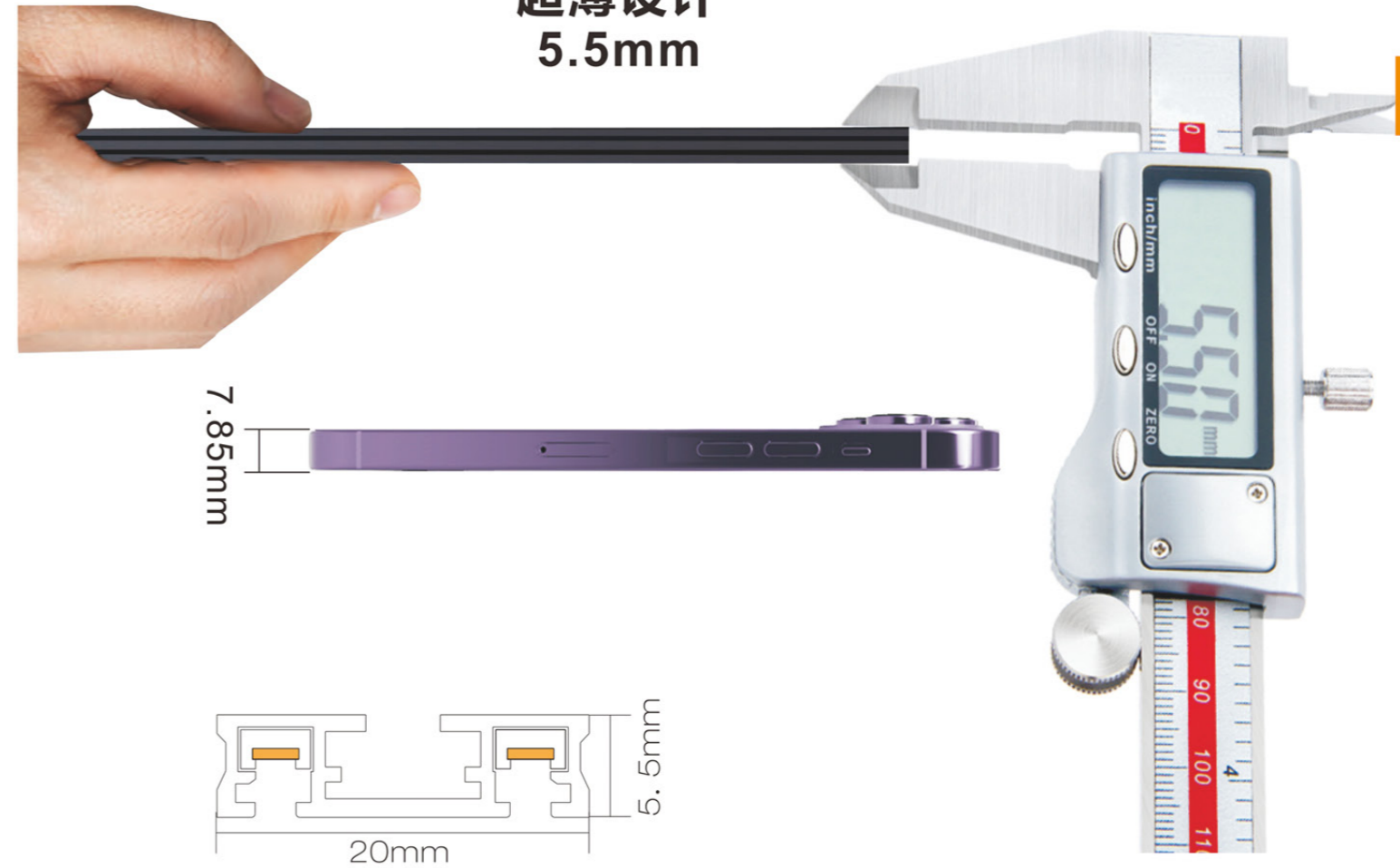

名称/Name: I型接头 / I-shaped joint  
材质/Material: 塑料+铜/Pc+Copper  
颜色/Colour: 砂白、砂黑/White, Black  
尺寸/Size: 56x20x5.5mm

名称/Name: L型接头 / L-shaped joint  
材质/Material: 塑料+铜/Pc+Copper  
颜色/Colour: 砂白、砂黑/White, Black  
尺寸/Size: 38\*38\*5.5mm

名称/Name: T型接头 / T-shaped joint  
材质/Material: 塑料+铜/Pc+Copper  
颜色/Colour: 砂白、砂黑/White, Black  
尺寸/Size: 56\*38\*5.5mm

名称/Name: 十型接头 / 十-shaped joint  
材质/Material: 塑料+铜/Pc+Copper  
颜色/Colour: 砂白、砂黑/White, Black  
尺寸/Size: 56\*56\*5.5mm

名称/Name: 7型接头 / 7-shaped joint  
材质/Material: 塑料+铜/Pc+Copper  
颜色/Colour: 砂白、砂黑/White, Black  
尺寸/Size: 27\*27\*5.5mm



名称/Name: L型接头 / L-shaped joint  
材质/Material: 铝材/Aluminum  
颜色/Colour: 砂白、砂黑/White, Black

名称/Name: 7型接头 / 7-shaped joint  
材质/Material: 铝材/Aluminum  
颜色/Colour: 砂白、砂黑/White, Black

名称/Name: 通电模块 / Power on module  
材质/Material: 塑料+铜/Pc+Copper  
颜色/Colour: 砂白、砂黑/White, Black

名称/Name: 导电模块 / Conductive module  
材质/Material: 塑料+铜/Pc+Copper  
颜色/Colour: 砂白、砂黑/White, Black

名称/Name: 48V 100W/200W 内置一体电源  
材质/Material: 塑料+铜/Pc+Copper  
颜色/Colour: 砂白、砂黑/White, Black

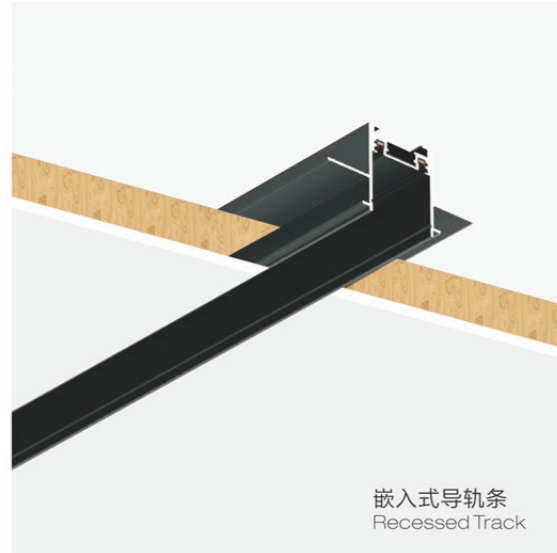

型号/Model	尺寸/Size	材质/Material	颜色/Color
LD-C02210	1000x24x30mm	铝材/Aluminum	砂白、砂黑/White、Black
LD-C02220	2000x24x30mm	铝材/Aluminum	砂白、砂黑/White、Black
LD-C02230	3000x24x30mm	铝材/Aluminum	砂白、砂黑/White、Black

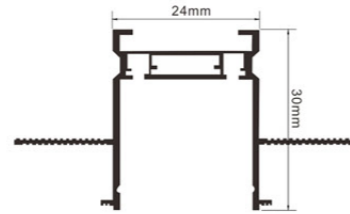

型号/Model	尺寸/Size	材质/Material	颜色/Color
LD-C02310	1000x24x30mm	铝材/Aluminum	砂白、砂黑/White、Black
LD-C02320	2000x24x30mm	铝材/Aluminum	砂白、砂黑/White、Black
LD-C02330	3000x24x30mm	铝材/Aluminum	砂白、砂黑/White、Black

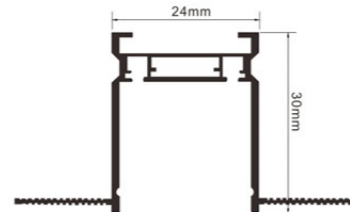

型号/Model	尺寸/Size	材质/Material	颜色/Color
LD-C02410	1000x24x30mm	铝材/Aluminum	砂白、砂黑/White、Black
LD-C02420	2000x24x30mm	铝材/Aluminum	砂白、砂黑/White、Black
LD-C02430	3000x24x30mm	铝材/Aluminum	砂白、砂黑/White、Black

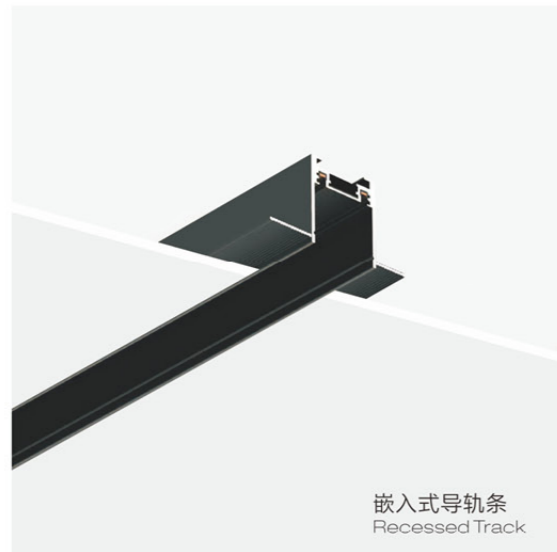
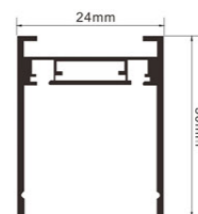

**导轨可根据不同的需求自由拼接组合，  
满足不同的设计需求。**

**The guide rails can be freely spliced and combined according to  
different needs, Meet different design needs.**

未来空间照明主流，开始流行性，简约的线性照明，简约的室内家居风格装饰，  
越来越被人们喜爱，简约的线性灯和轨道磁吸灯具开始占主流。

The mainstream of future space lighting is becoming popular, with simple linear lighting and simple indoor home style decoration,  
Increasingly loved by people, minimalist linear lamps and track magnetic absorption lamps are becoming mainstream.

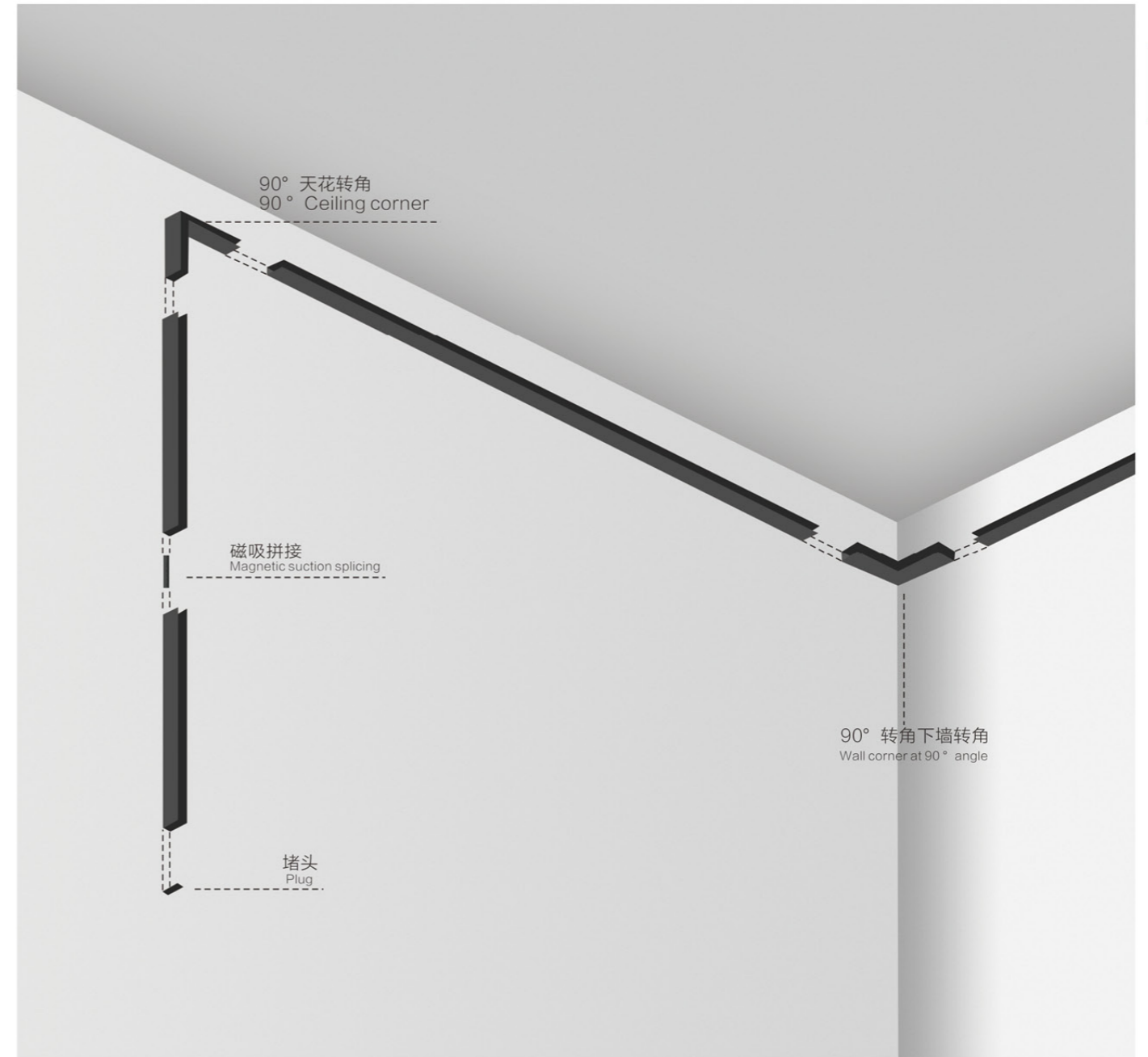



优点:

压铸铝灯体, 体积小, 隐蔽性好, 美观简洁  
优质LED光源, 高亮, 高效, 寿命长

灯具模组有泛光下照明式、洗墙式及射灯模组, 可多种产品组合方案  
多种类型组合, 满足各应用环境/场所对空间构造之点、线、面照明需求  
可广泛应用于别墅、商业前台、商业店铺及展览展示等场所照明

Advantage:

Aluminum alloy profile lamp body, compact size, good concealment, beautiful and concise  
High quality LED light source, high brightness, high efficiency, and long service life  
Luminaire modules include floodlighting, wall washing, and spotlighting modules, which can be combined with various product solutions  
Multiple types of combinations to meet the lighting needs of various application environments/locations for spatial construction points, lines, and surfaces  
Widely used for lighting in villas, commercial front desk, commercial stores, exhibitions, and other places

磁吸轨道不同组合应用

Different combinations of magnetic tracks

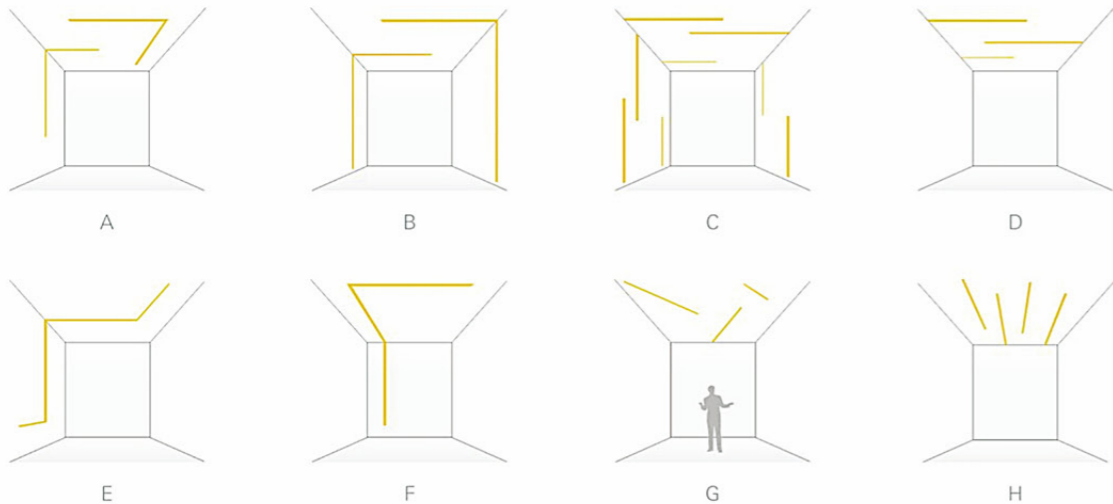

磁吸轨道照明系统能实现各种布光设计。  
The magnetic track lighting system can realize various lighting designs.

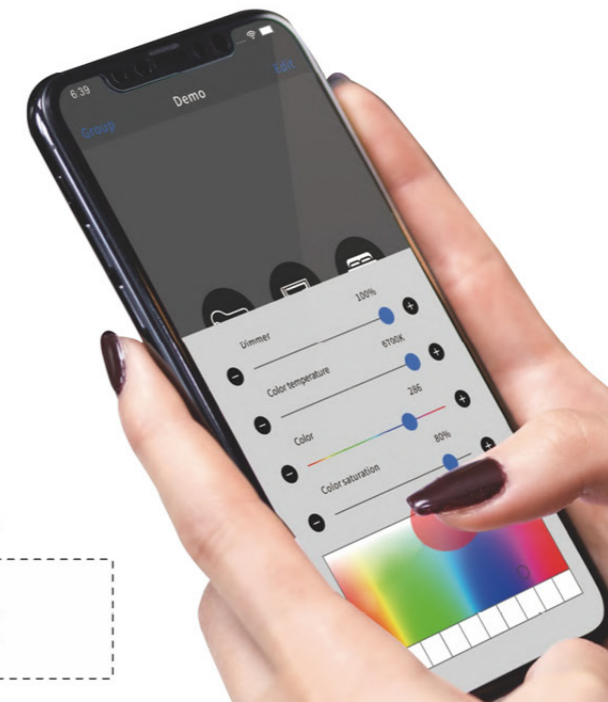

智能调光系统  
Intelligent dimming system



005

006

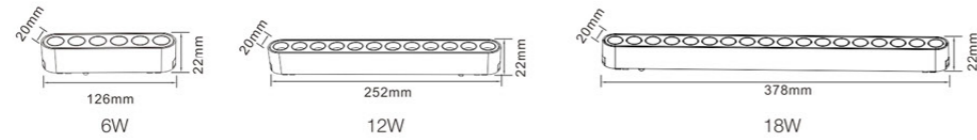
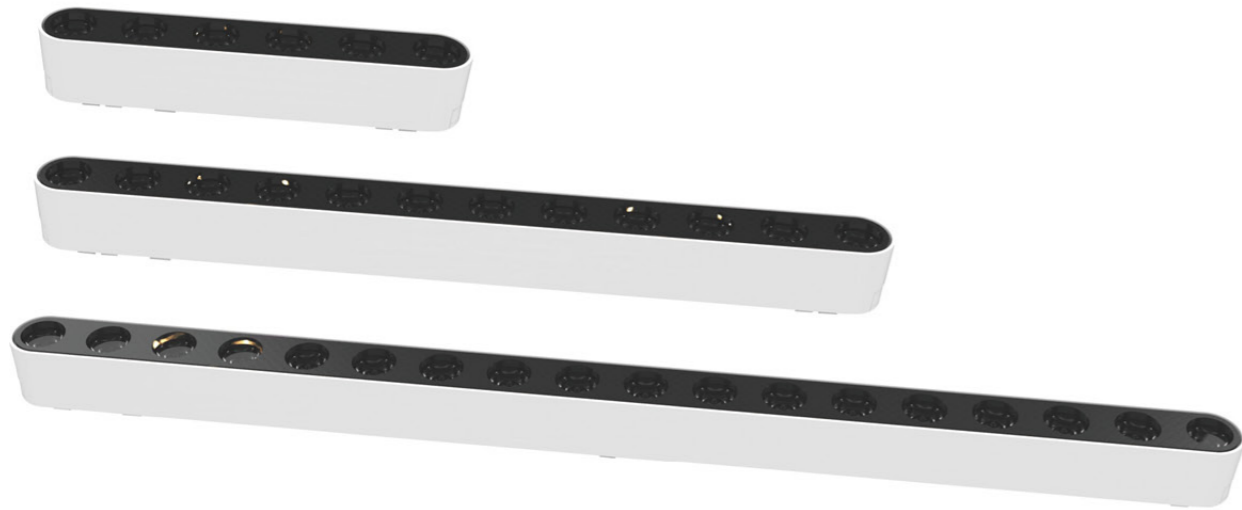

48V磁吸  
48V Magnetic suction

型号/Model	功率/Power	光源/light source	输入电压/Input voltage	显色指数/CRI	光通量/Luminous flux	材质/Material
LD-C02A06	6W	SMD3030	48V	Ra>90	510lm	压铸铝/Aluminum
LD-C02A12	12W	SMD3030	48V	Ra>90	1020lm	压铸铝/Aluminum
LD-C02A18	18W	SMD3030	48V	Ra>90	1530lm	压铸铝/Aluminum

Light Source



Driver



色温/CCT 3000K 4000K 6000K  
颜色/Color 砂白/White 砂黑/Black

专用轨道 Alternative dedicated track



明装超薄导轨 嵌入式专用导轨 嵌入式专用导轨 明装/吊线专用导轨

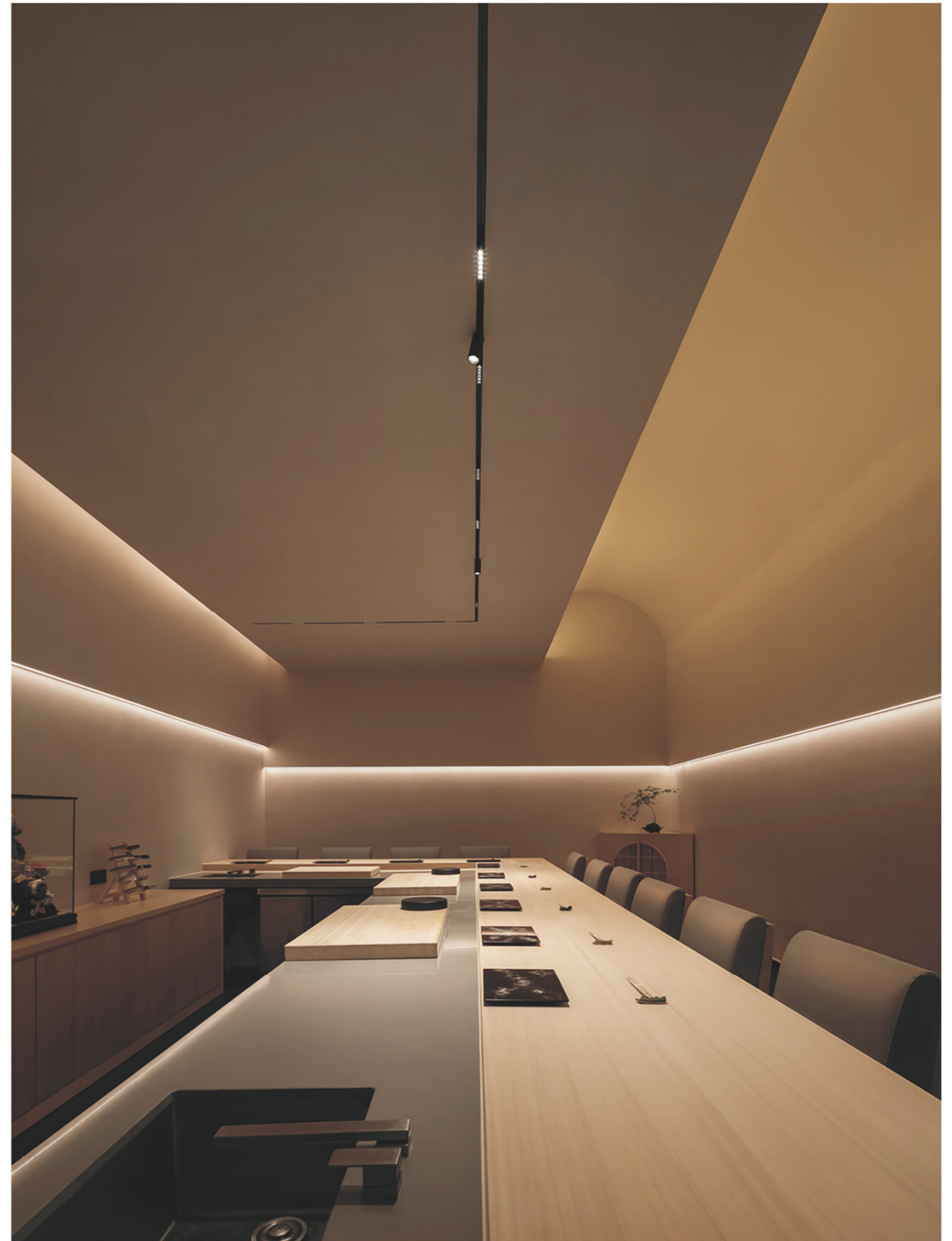

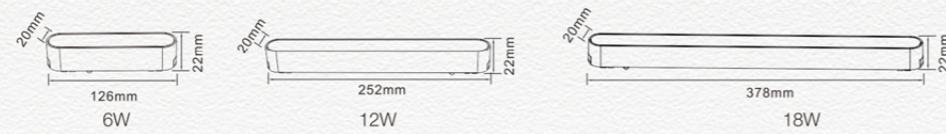
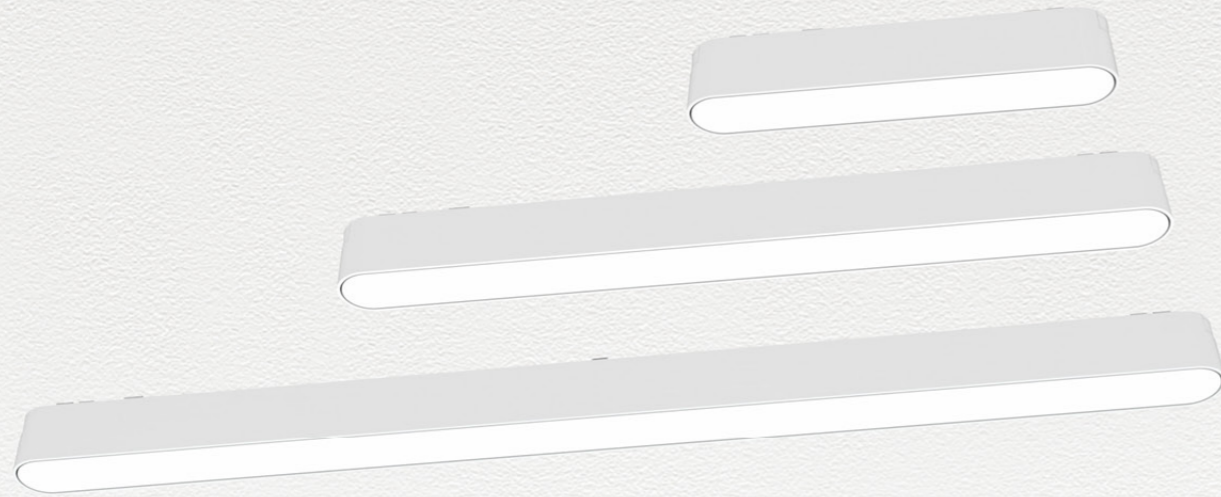

48V磁吸  
48V Magnetic suction

型号/Model	功率/Power	光源/light source	输入电压/Input voltage	显色指数/CRI	光通量/Luminous flux	材质/Material
LD-C02C06	6W	SMD2835	48V	Ra>90	510lm	压铸铝/Aluminum
LD-C02C12	12W	SMD2835	48V	Ra>90	1020lm	压铸铝/Aluminum
LD-C02C18	18W	SMD2835	48V	Ra>90	1530lm	压铸铝/Aluminum

Light Source



Driver

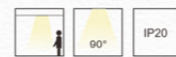

色温/CCT 3000K 4000K 6000K  
颜色/Color 砂白/White 砂黑/Black

专用轨道 Alternative dedicated track



明装超薄导轨 嵌入式专用导轨 嵌入式专用导轨 明装/吊线专用导轨



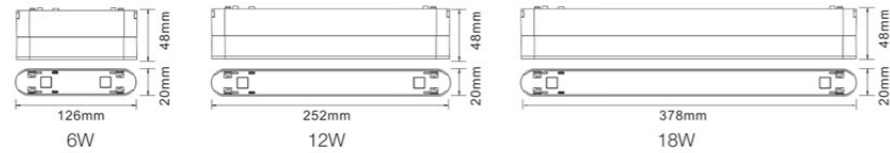
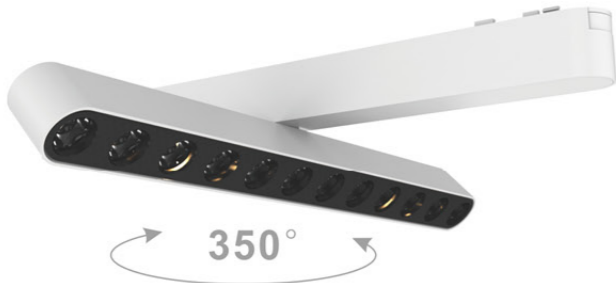

48V磁吸  
48V Magnetic suction

型号/Model	功率/Power	光源/light source	输入电压/Input voltage	显色指数/CRI	光通量/Luminous flux	材质/Material
LD-C02D06	6W	SMD3030	48V	Ra>90	510lm	压铸铝/Aluminum
LD-C02D12	12W	SMD3030	48V	Ra>90	1020lm	压铸铝/Aluminum
LD-C02D18	18W	SMD3030	48V	Ra>90	1530lm	压铸铝/Aluminum

Light Source



色温/CCT 3000K 4000K 6000K  
颜色/Color 砂白/White 砂黑/Black

Driver



专用轨道 Alternative dedicated track



明装超薄导轨 嵌入式专用导轨 嵌入式专用导轨 明装/吊线专用导轨



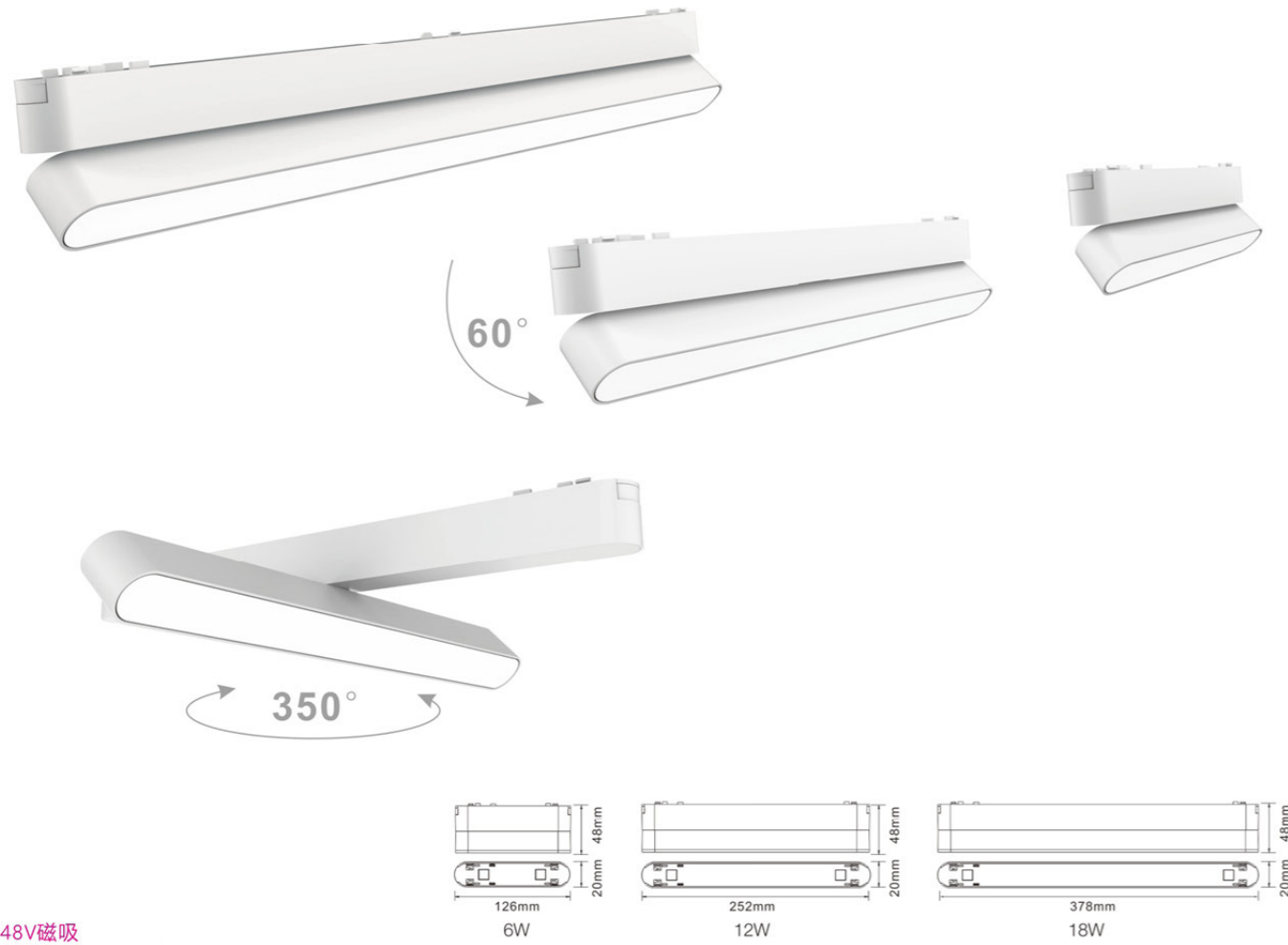

48V磁吸  
48V Magnetic suction

型号/Model	功率/Power	光源/light source	输入电压/Input voltage	显色指数/CRI	光通量/Luminous flux	材质/Material
LD-C02B06	6W	SMD2835	48V	Ra>90	510lm	压铸铝/Aluminum
LD-C02B12	12W	SMD2835	48V	Ra>90	1020lm	压铸铝/Aluminum
LD-C02B18	18W	SMD2835	48V	Ra>90	1530lm	压铸铝/Aluminum

Light Source



Driver



专用轨道 Alternative dedicated track

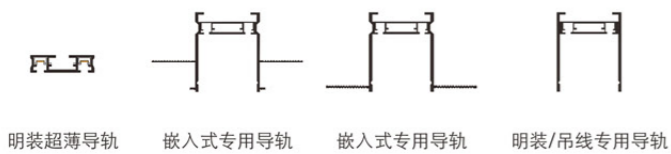

明装超薄导轨 嵌入式专用导轨 嵌入式专用导轨 明装/吊线专用导轨



48V磁吸  
48V Magnetic suction

型号/Model	功率/Power	光源/light source	输入电压/Input voltage	显色指数/CRI	光通量/Luminous flux	材质/Material
LD-C02E06	6W	COB	48V	Ra>90	600lm	压铸铝/Aluminum
LD-C02E12	12W	COB	48V	Ra>90	1200lm	压铸铝/Aluminum
LD-C02E24	24W	COB	48V	Ra>90	2400lm	压铸铝/Aluminum

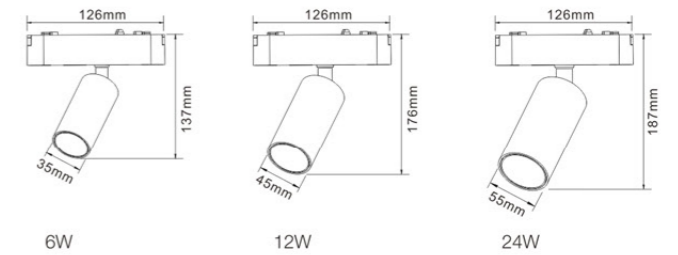

Light Source



Driver



专用轨道 Alternative dedicated track

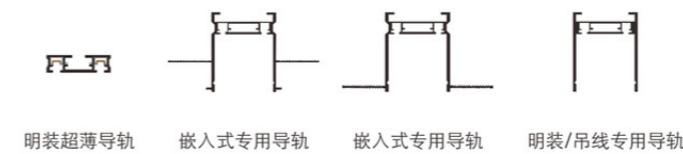

明装超薄导轨 嵌入式专用导轨 嵌入式专用导轨 明装/吊线专用导轨

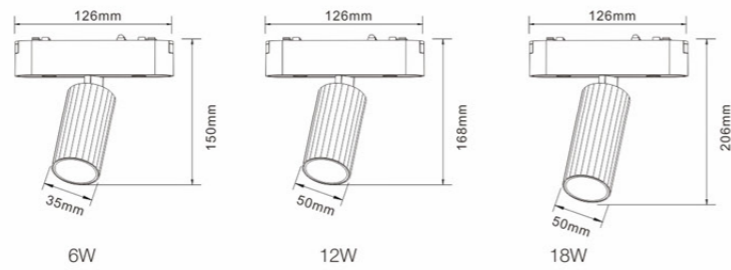

48V磁吸  
48V Magnetic suction

型号/Model	功率/Power	光源/light source	输入电压/Input voltage	显色指数/CRI	光通量/Luminous flux	材质/Material
LD-C02G06	6W	COB	48V	Ra ≥ 90	600lm	压铸铝/Aluminum
LD-C02G12	12W	COB	48V	Ra ≥ 90	1200lm	压铸铝/Aluminum
LD-C02G18	18W	COB	48V	Ra ≥ 90	1800lm	压铸铝/Aluminum

Light Source



Driver



色温/CCT 3000K 4000K 6000K  
颜色/Color 砂白/White 砂黑/Black

专用轨道 Alternative dedicated track



明装超薄导轨 嵌入式专用导轨 嵌入式专用导轨 明装/吊线专用导轨

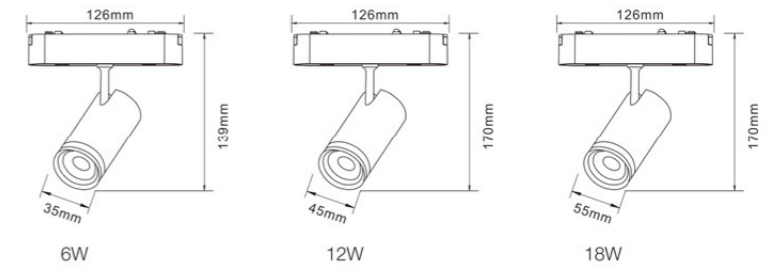
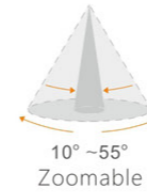

48V磁吸  
48V Magnetic suction

型号/Model	功率/Power	光源/light source	输入电压/Input voltage	显色指数/CRI	光通量/Luminous flux	材质/Material
LD-C02H06	6W	COB	48V	Ra ≥ 90	600lm	压铸铝/Aluminum
LD-C02H12	12W	COB	48V	Ra ≥ 90	1200lm	压铸铝/Aluminum
LD-C02H18	18W	COB	48V	Ra ≥ 90	1800lm	压铸铝/Aluminum

Light Source



Driver



色温/CCT 3000K 4000K 6000K  
颜色/Color 砂白/White 砂黑/Black

专用轨道 Alternative dedicated track

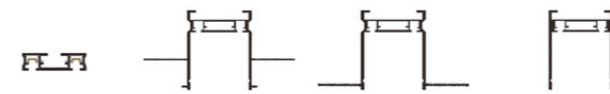

明装超薄导轨 嵌入式专用导轨 嵌入式专用导轨 明装/吊线专用导轨



017

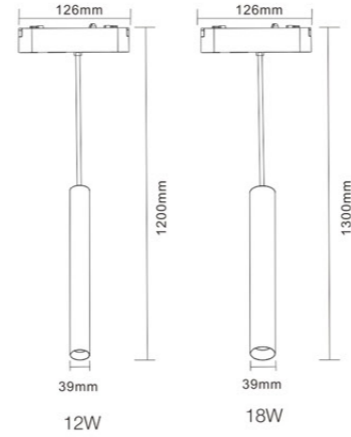
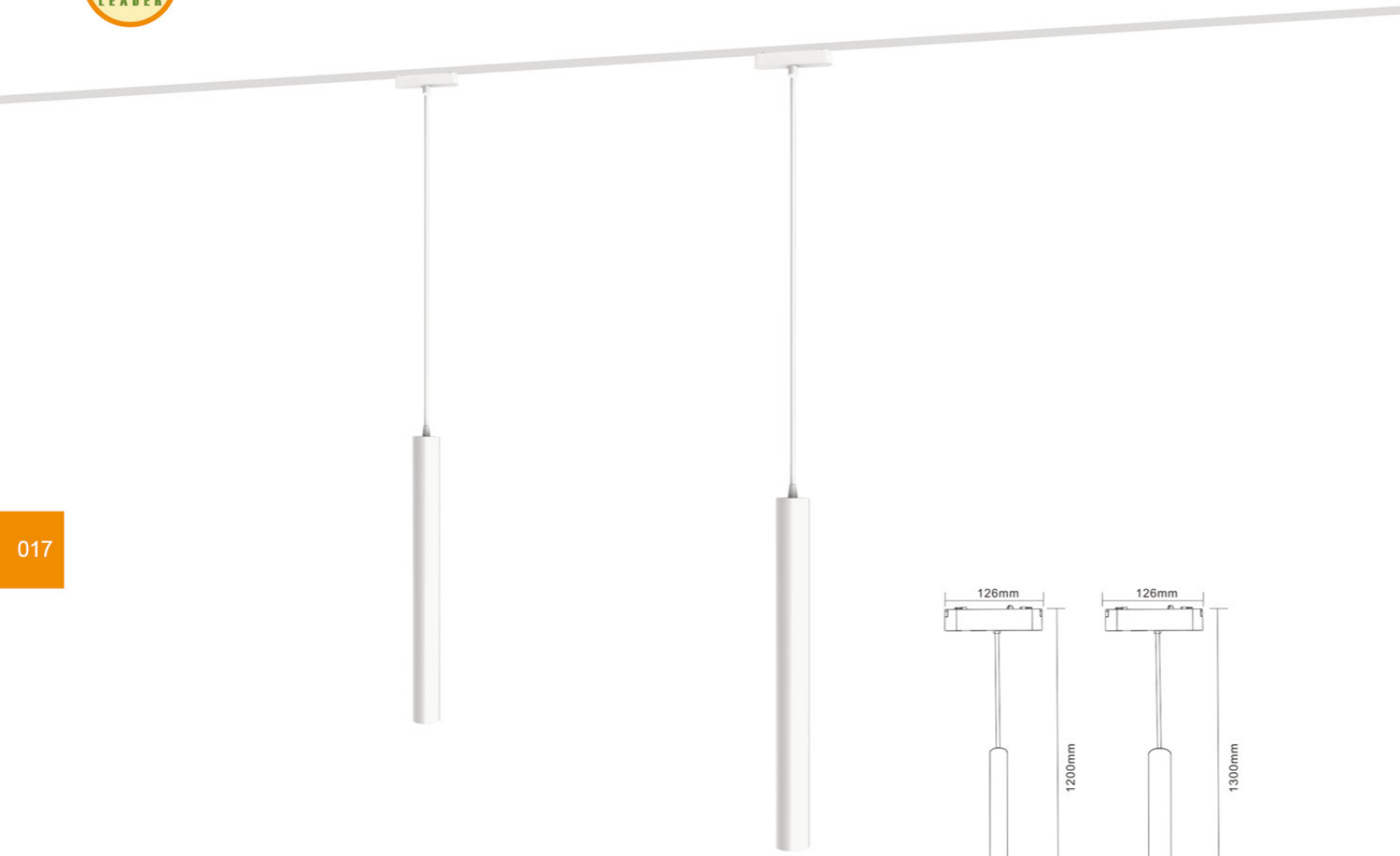

48V磁吸  
48V Magnetic suction

型号/Model	功率/Power	光源/light source	输入电压/Input voltage	显色指数/CRI	光通量/Luminous flux	材质/Material
LD-C02F12	12W	COB	48V	Ra > 90	1200lm	压铸铝/Aluminum
LD-C02F18	18W	COB	48V	Ra > 90	1800lm	压铸铝/Aluminum

Light Source



Driver



色温/CCT 3000K 4000K 6000K  
颜色/Color 砂白/White 砂黑/Black

专用轨道 Alternative dedicated track

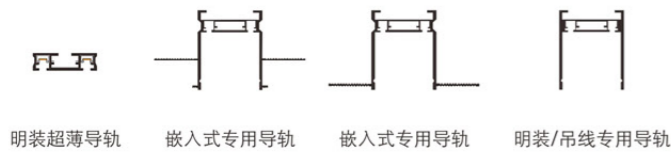

018



48V磁吸  
48V Magnetic suction

型号/Model	功率/Power	光源/light source	输入电压/Input voltage	显色指数/CRI	光通量/Luminous flux	材质/Material
LD-C02K06-D	6W	COB	48V	Ra > 90	600lm	压铸铝/Aluminum
LD-C02K06-Y	6W	COB	48V	Ra > 90	600lm	压铸铝/Aluminum

Light Source



Driver



色温/CCT 3000K 4000K 6000K  
颜色/Color 砂白/White 砂黑/Black

专用轨道 Alternative dedicated track

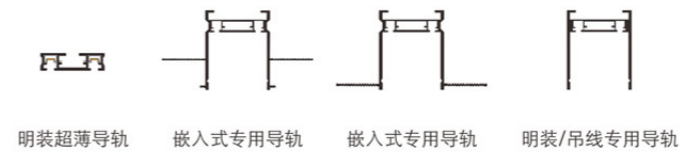



019

020

## 220V磁吸组合式照明系统

磁吸轨道通过不同的轨道槽配件组合成不同形体，满足相应空间与家具布置，更加灵活地形成虚拟有趣空间灯光区隔。

更加系统化的照明效果实现方案，提供了同时满足一个空间的多种照明需求，一般照明、重点照明、洗墙照明、区域任务照明甚至间接照明都可以轻松实现。

## 220V Magnetic attraction combined lighting system

Magnetic rails are combined into different shapes through different rail slot accessories to meet the corresponding space and furniture layout, more flexible. Lively form a virtual interesting space lighting segment.

A more systematic realization scheme of lighting effects, which provides multiple lighting requirements for a space at the same time. Ming, key lighting, wall washing lighting, area task lighting and even indirect lighting can be easily achieved.



## LD-25系列

各种规格  
Various specifications

According to the size of customers' needs, cut it into different lengths, match with different shapes to reflect different lighting effects.

All available with Suspended, surface mounted and recessed mounted versions.

根据客户需求尺寸，裁剪成不同的长度，搭配不同造型来体现不同灯光效果。

所有产品均提供吊线式、明装安装式和嵌入式安装式。

吊线导轨条  
Hanging Track明装导轨条  
Surface mounted Track嵌入式导轨条  
Recessed Track嵌入式导轨条  
Recessed Track

021

022

型号/Model	尺寸/Size	材质/Material	颜色/Color
LD-C01110	1000x68x57mm	铝材/Aluminum	砂白、砂黑/White、Black
LD-C01120	2000x68x57mm	铝材/Aluminum	砂白、砂黑/White、Black
LD-C01130	3000x68x57mm	铝材/Aluminum	砂白、砂黑/White、Black

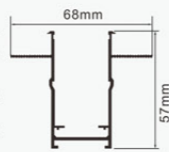

型号/Model	尺寸/Size	材质/Material	颜色/Color
LD-C01310	1000x68x57mm	铝材/Aluminum	砂白、砂黑/White、Black
LD-C01320	2000x68x57mm	铝材/Aluminum	砂白、砂黑/White、Black
LD-C01330	3000x68x57mm	铝材/Aluminum	砂白、砂黑/White、Black

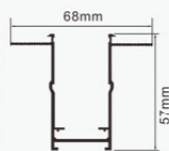

型号/Model	尺寸/Size	材质/Material	颜色/Color
LD-C01210	1000x30x57mm	铝材/Aluminum	砂白、砂黑/White、Black
LD-C01220	2000x30x57mm	铝材/Aluminum	砂白、砂黑/White、Black
LD-C01230	3000x30x57mm	铝材/Aluminum	砂白、砂黑/White、Black

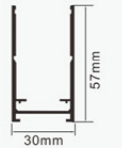

名称/Name: 通电模块(带输入线)  
Power on module (with input line)  
材质/Material: 塑料/PC  
颜色/Colour: 砂白、砂黑/White、Black

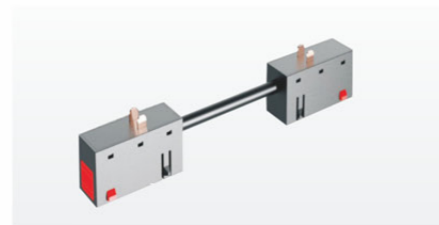

名称/Name: 双头导电(中间带线)  
Double head conductive (with wire in the middle)  
材质/Material: 塑料/PC  
颜色/Colour: 砂白、砂黑/White、Black



名称/Name: 转角导电(带200长线)  
Corner conductivity (with 200 long wires)  
材质/Material: 塑料/PC  
颜色/Colour: 砂白、砂黑/White、Black

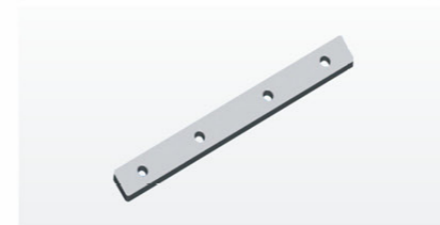

名称/Name: 一字连接件  
Straight connector  
材质/Material: 铝材/Aluminum  
颜色/Colour: 砂白、砂黑/White、Black  
尺寸/Size: 100x9.7x2.5mm

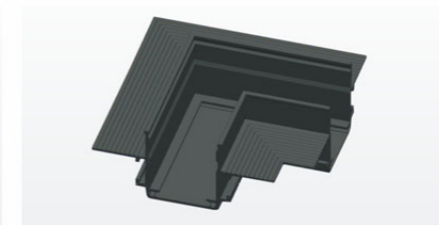

名称/Name: L形预埋磁吸导轨接头  
L-shaped embedded magnetic guide rail joint  
材质/Material: 铝材/Aluminum  
颜色/Colour: 砂白、砂黑/White、Black  
尺寸/Size: 100x100x68mm

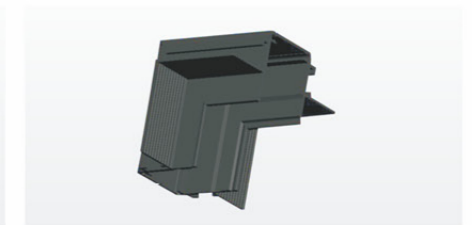

名称/Name: 7形预埋磁吸导轨接头  
7-shaped embedded magnetic guide rail joint  
材质/Material: 铝材/Aluminum  
颜色/Colour: 砂白、砂黑/White、Black  
尺寸/Size: 100x100x68mm

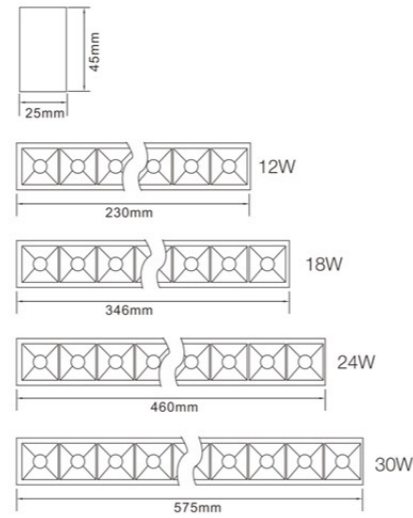

220V磁吸  
220V Magnetic suction

型号/Model	功率/Power	光源/light source	输入电压/Input voltage	显色指数/CRI	光通量/Luminous flux	材质/Material
LD-C01A12	12W	SMD3030	100-265V	Ra>90	1020lm	铝材/Aluminum
LD-C01A18	18W	SMD3030	100-265V	Ra>90	1530lm	铝材/Aluminum
LD-C01A24	24W	SMD3030	100-265V	Ra>90	2040lm	铝材/Aluminum
LD-C01A30	30W	SMD3030	100-265V	Ra>90	2550lm	铝材/Aluminum

Light Source



色温/CCT 3000K 4000K 6000K  
颜色/Color 砂白/White 砂黑/Black

Driver



专用轨道 Alternative dedicated track

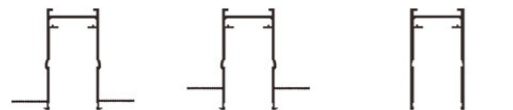

嵌入式专用导轨 嵌入式专用导轨 明装/吊线专用导轨

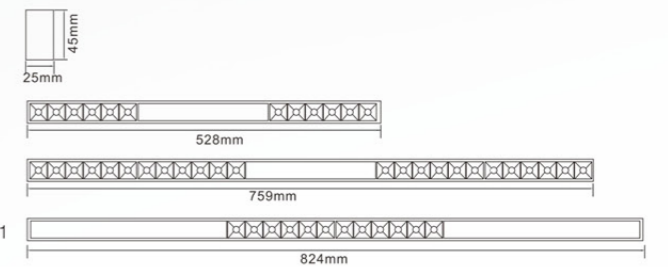
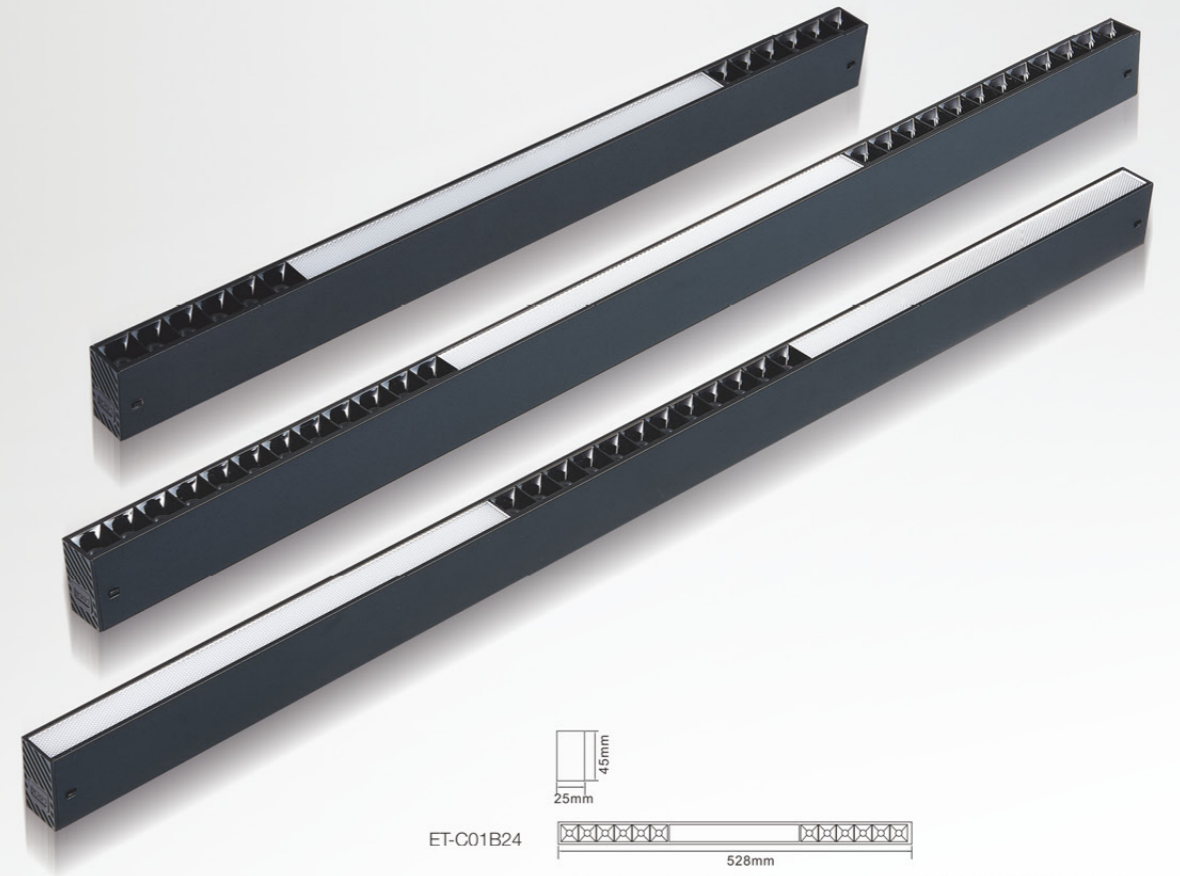

220V磁吸  
220V Magnetic suction

型号/Model	功率/Power	光源/light source	输入电压/Input voltage	显色指数/CRI	光通量/Luminous flux	材质/Material
LD-C01B24	24W	SMD3030+2835	100-265V	Ra>90	2040lm	铝材/Aluminum
LD-C01B30	30W	SMD3030+2835	100-265V	Ra>90	2550lm	铝材/Aluminum
LD-C01B30-1	30W	SMD3030+2835	100-265V	Ra>90	2550lm	铝材/Aluminum

Light Source



色温/CCT 3000K 4000K 6000K  
颜色/Color 砂白/White 砂黑/Black

Driver



专用轨道 Alternative dedicated track

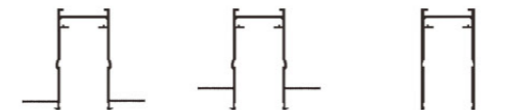

嵌入式专用导轨 嵌入式专用导轨 明装/吊线专用导轨



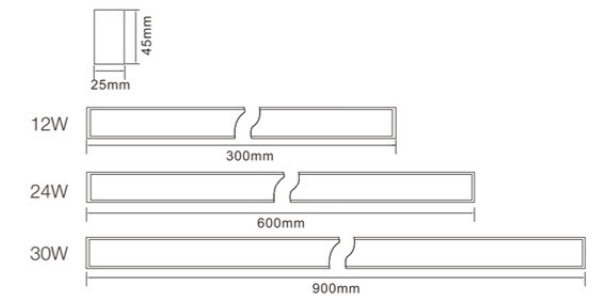
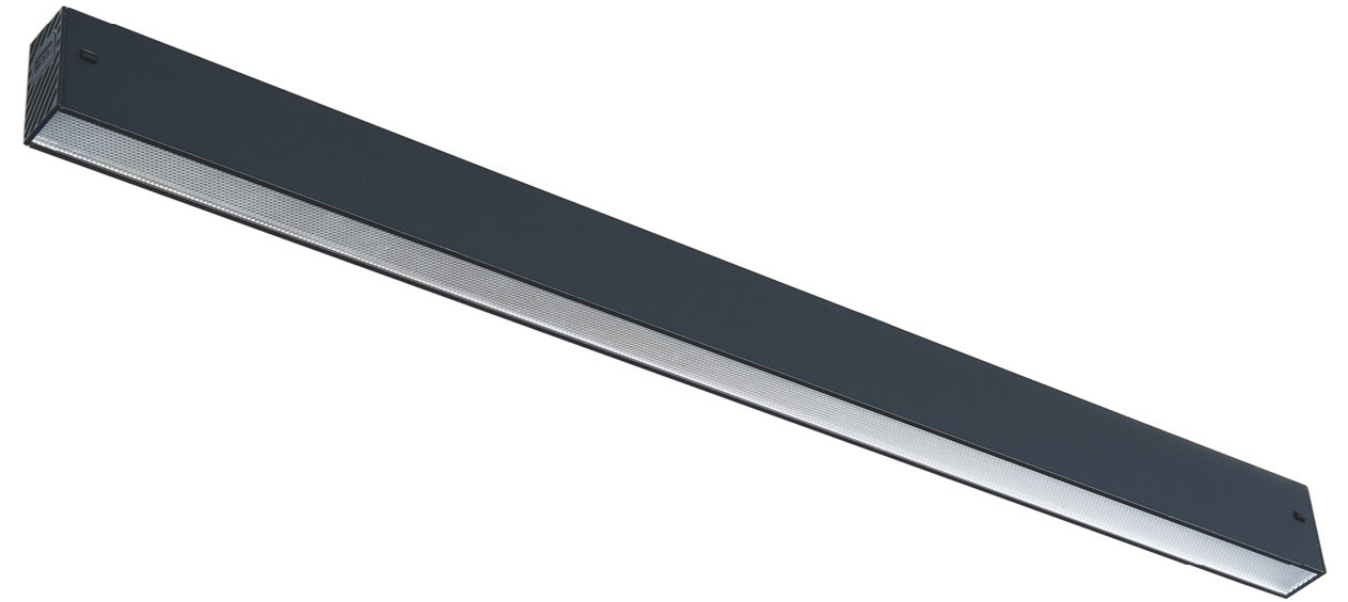

220V磁吸  
220V Magnetic suction

型号/Model	功率/Power	光源/light source	输入电压/Input voltage	显色指数/CRI	光通量/Luminous flux	材质/Material
LD-C01C12	12W	SMD2835	100-265V	Ra>90	1020lm	铝材/Aluminum
LD-C01C24	24W	SMD2835	100-265V	Ra>90	2040lm	铝材/Aluminum
LD-C01C30	30W	SMD2835	100-265V	Ra>90	2550lm	铝材/Aluminum

Light Source



Driver

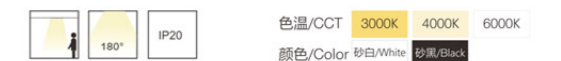

色温/CCT 3000K 4000K 6000K  
颜色/Color 砂白/White 砂黑/Black

专用轨道 Alternative dedicated track



嵌入式专用导轨 嵌入式专用导轨 明装/吊线专用导轨

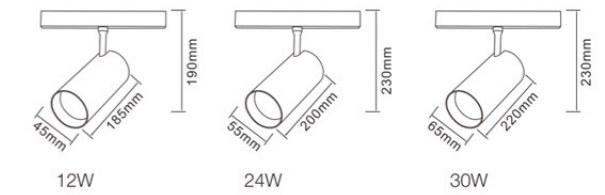
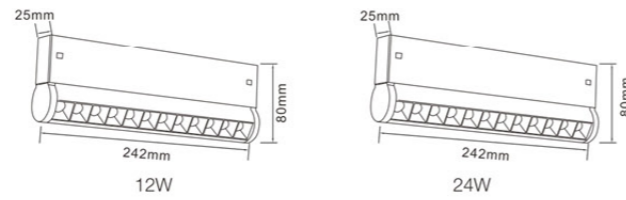

 220V磁吸  
220V Magnetic suction

 220V磁吸  
220V Magnetic suction

型号/Model	功率/Power	光源/light source	输入电压/Input voltage	显色指数/CRI	光通量/Luminous flux	材质/Material
LD-C01D12	12W	SMD3030	100-265V	Ra > 90	1020lm	铝材/Aluminum
LD-C01D24	24W	SMD3030	100-265V	Ra > 90	2040lm	铝材/Aluminum

型号/Model	功率/Power	光源/light source	输入电压/Input voltage	显色指数/CRI	光通量/Luminous flux	材质/Material
LD-C01E12	12W	COB	100-265V	Ra > 90	1200lm	铝材/Aluminum
LD-C01E24	24W	COB	100-265V	Ra > 90	2400lm	铝材/Aluminum
LD-C01E30	30W	COB	100-265V	Ra > 90	3000lm	铝材/Aluminum

## Light Source

 色温/CCT 3000K 4000K 6000K  
颜色/Color 砂白/White 砂黑/Black

## Driver



## 专用轨道 Alternative dedicated track



嵌入式专用导轨 嵌入式专用导轨 明装/吊线专用导轨

## Light Source

 色温/CCT 3000K 4000K 6000K  
颜色/Color 砂白/White 砂黑/Black

## Driver



## 专用轨道 Alternative dedicated track



嵌入式专用导轨 嵌入式专用导轨 明装/吊线专用导轨

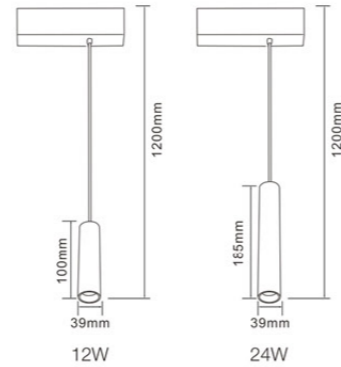

220V磁吸  
220V Magnetic suction

型号/Model	功率/Power	光源/light source	输入电压/Input voltage	显色指数/CRI	光通量/Luminous flux	材质/Material
LD-C01F12	12W	C0B	100-265V	Ra > 90	1200lm	铝材/Aluminum
LD-C01F24	24W	C0B	100-265V	Ra > 90	2400lm	铝材/Aluminum

Light Source



Driver



色温/CCT 3000K 4000K 6000K  
颜色/Color 砂白/White 砂黑/Black

专用轨道 Alternative dedicated track

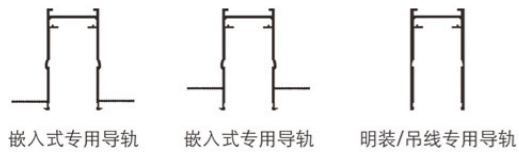



031

032

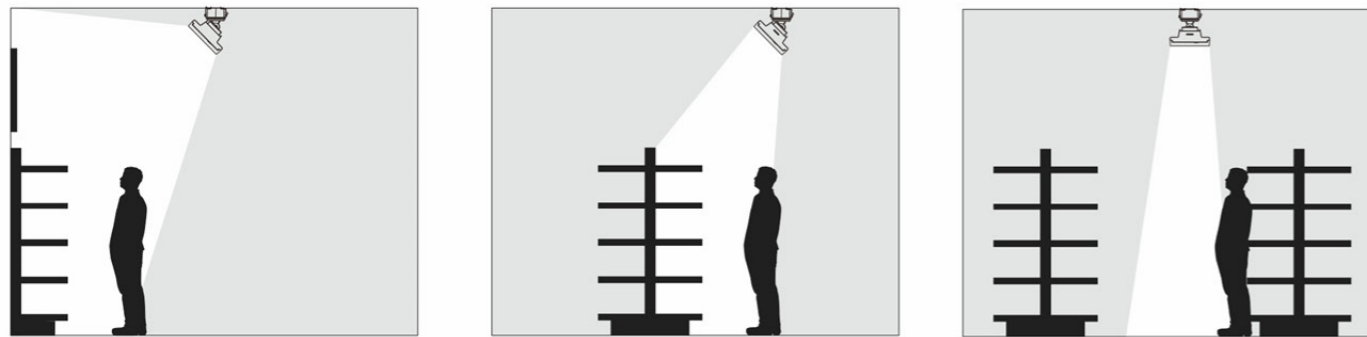
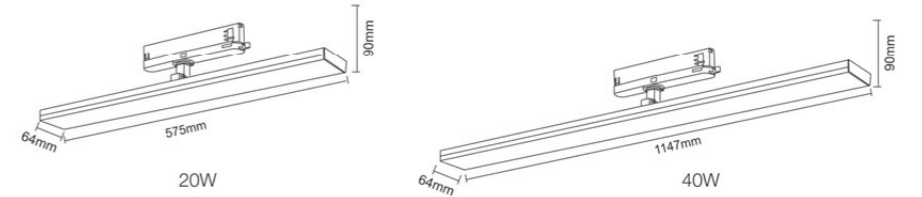

墙体地板 (单面)  
Wall Floor (single-side)

货架地板(单面)  
Shelf Floor (single-side)

通道(地板)  
Aisle (floor)

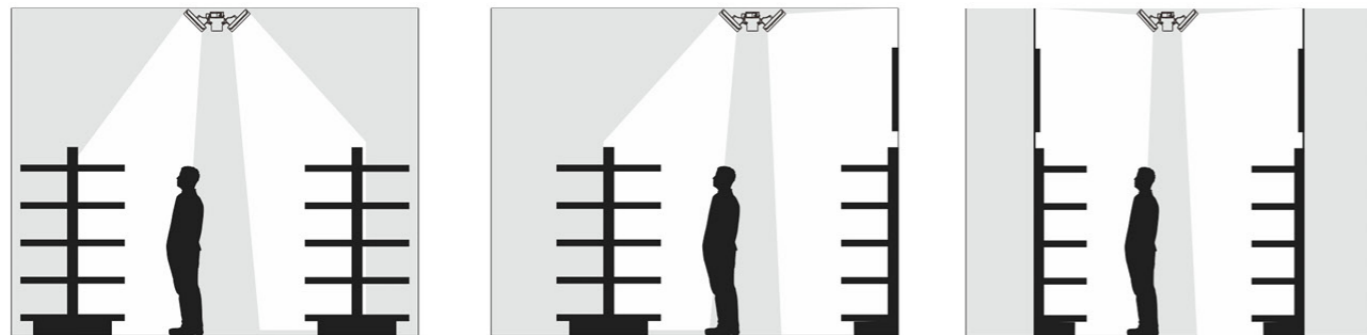

货架地板(双面)  
Shelf Floor (double-side)

货架/墙面地板  
Shelf / Wall Floor

墙面地板 (双面)  
Wall Floor (double-side)

型号/Model	功率/Power	光源/light source	输入电压/Input voltage	显色指数/CRI	光通量/Luminous flux	材质/Material
LD-H04020	20W	SMD2835	220-265V	Ra>90	2200lm±10%	铝材/Aluminum
LD-H04040	40W	SMD2835	220-265V	Ra≥90	4400lm±10%	铝材/Aluminum

Light Source

CREE, BRIDGELUX, CITILED, CITIZEN, OSRAM

Driver

EAGLE RISE, LIFUD, PHILIPS, TRIDONIC, OSRAM



色温/CCT 3000K 4000K 6000K  
颜色/Color 砂白/White 砂黑/Black

专用轨道 Alternative dedicated track

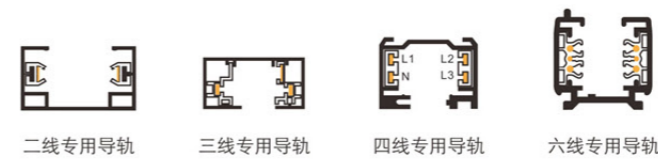

二线专用轨道 三线专用轨道 四线专用轨道 六线专用轨道



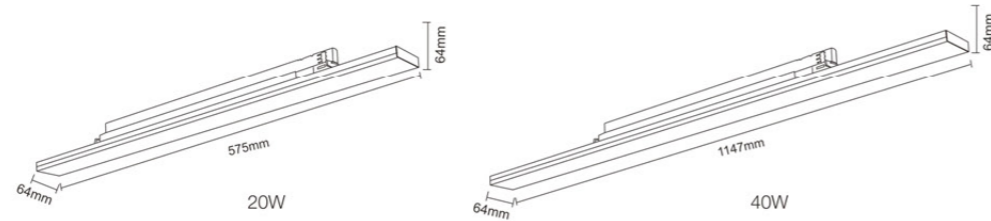

型号/Model	功率/Power	光源/light source	输入电压/Input voltage	显色指数/CRI	光通量/Luminous flux	材质/Material
LD-H05020	20W	SMD2835	220-265V	Ra≥90	2200lm±10%	铝材/Aluminum
LD-H05040	40W	SMD2835	220-265V	Ra≥90	4400lm±10%	铝材/Aluminum

Light Source



Driver



专用轨道 Alternative dedicated track

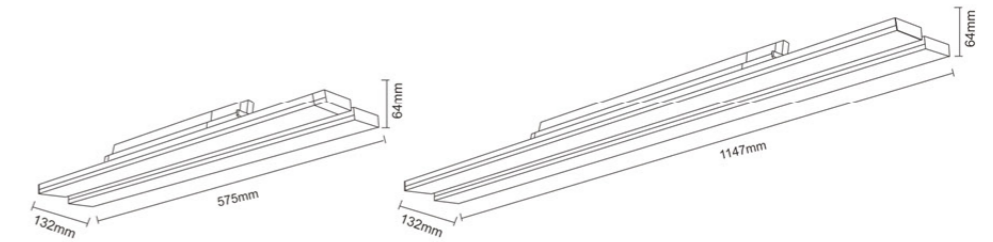
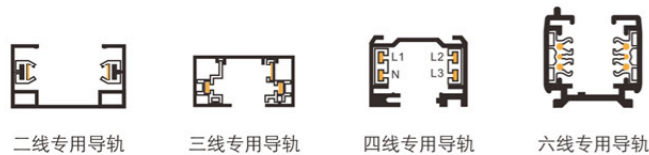

型号/Model	功率/Power	光源/light source	输入电压/Input voltage	显色指数/CRI	光通量/Luminous flux	材质/Material
LD-H06220	2x20W	SMD2835	220-265V	Ra≥90	2x2200lm±10%	铝材/Aluminum
LD-H06240	2x40W	SMD2835	220-265V	Ra≥90	2x4400lm±10%	铝材/Aluminum

Light Source



Driver



专用轨道 Alternative dedicated track



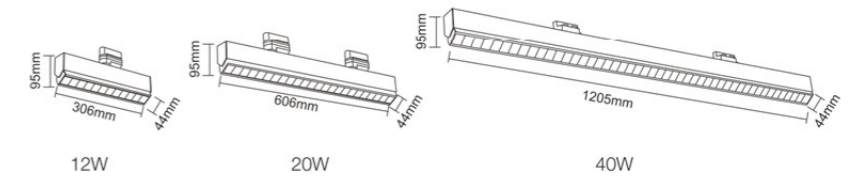
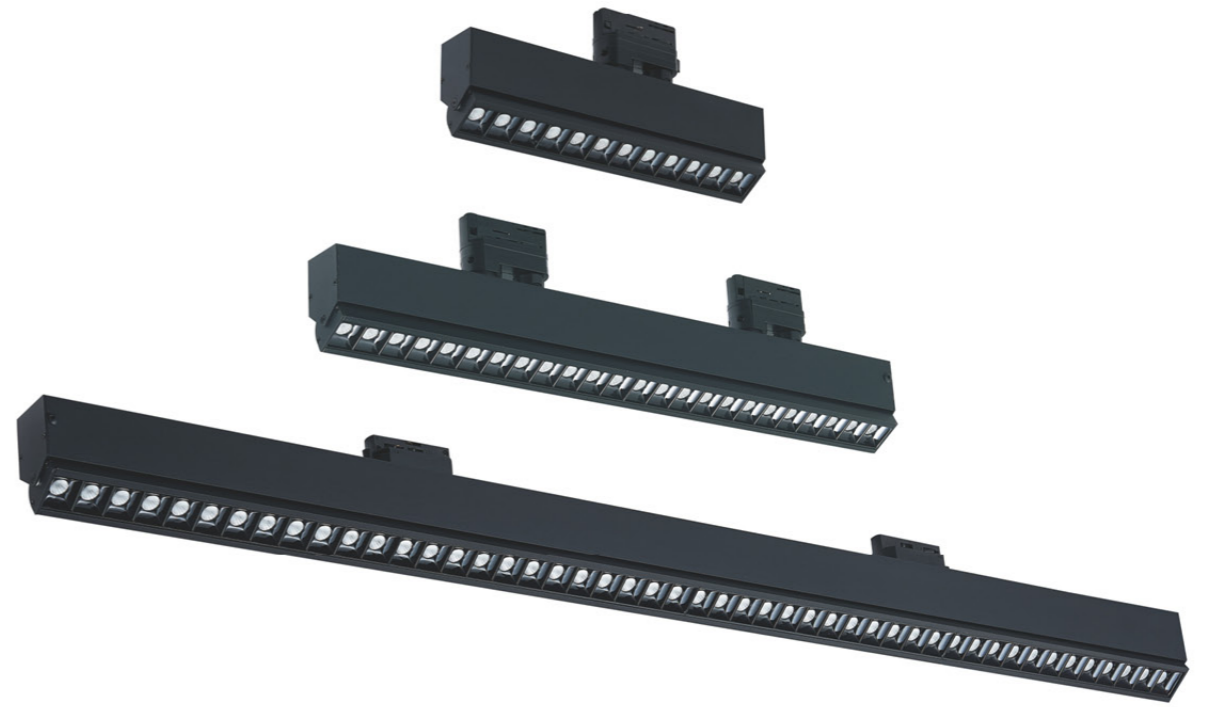

型号/Model	功率/Power	光源/light source	输入电压/Input voltage	显色指数/CRI	光通量/Luminous flux	材质/Material
LD-H01012	12W	SMD3030	220-265V	Ra > 90	900lm ± 10%	铝材/Aluminum
LD-H01020	20W	SMD3030	220-265V	Ra > 90	1500lm ± 10%	铝材/Aluminum
LD-H01040	40W	SMD3030	220-265V	Ra > 90	3000lm ± 10%	铝材/Aluminum

Light Source



Driver



专用轨道 Alternative dedicated track

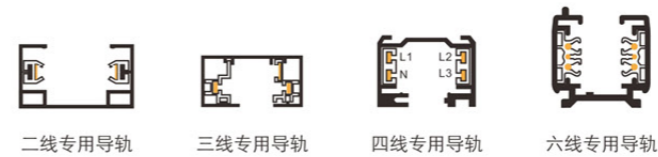

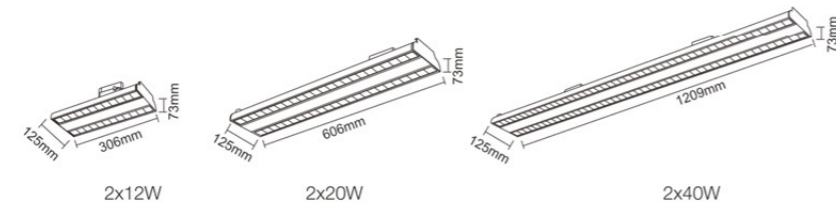
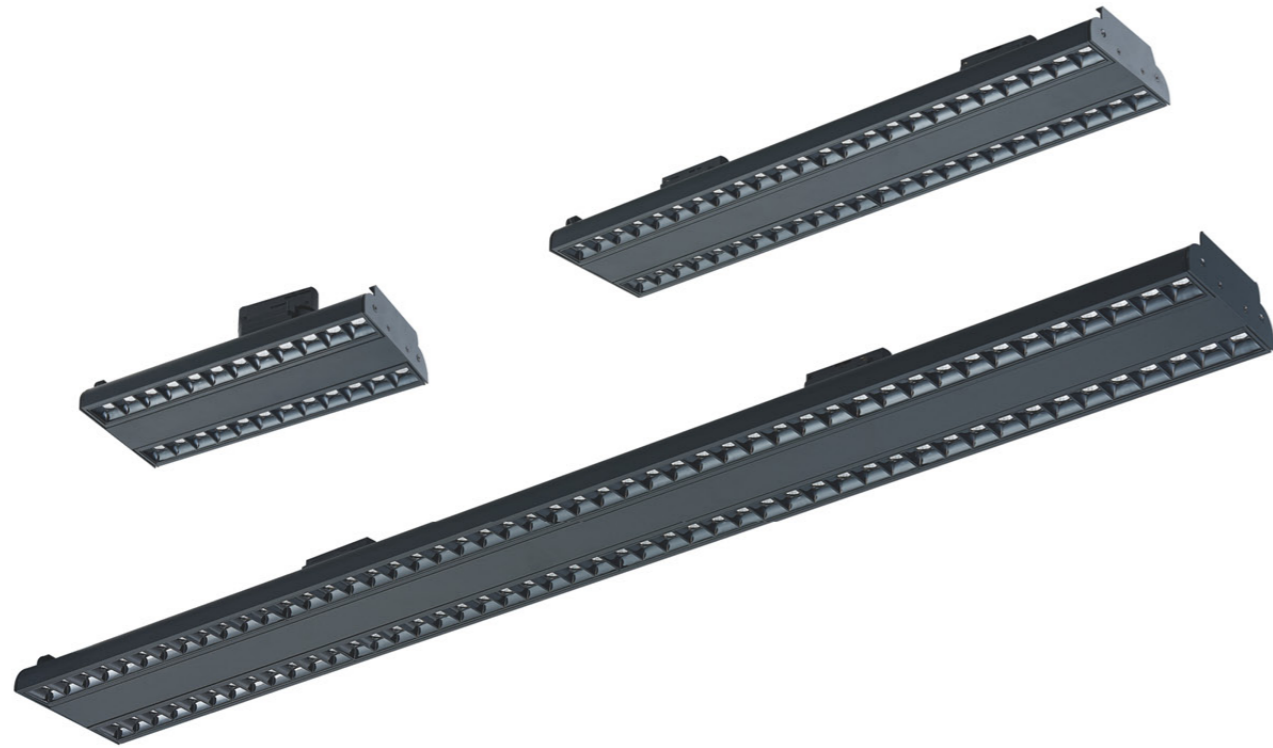

型号/Model	功率/Power	光源/light source	输入电压/Input voltage	显色指数/CRI	光通量/Luminous flux	材质/Material
LD-H02212	2x12W	SMD3030	220-265V	Ra > 90	1800lm ± 10%lm	铝材/Aluminum
LD-H02220	2x20W	SMD3030	220-265V	Ra > 90	3000lm ± 10%lm	铝材/Aluminum
LD-H02240	2x40W	SMD3030	220-265V	Ra > 90	6000lm ± 10%lm	铝材/Aluminum

Light Source



Driver



色温/CCT 3000K 4000K 6000K  
颜色/Color 暖白/White 冷白/Black

专用轨道 Alternative dedicated track

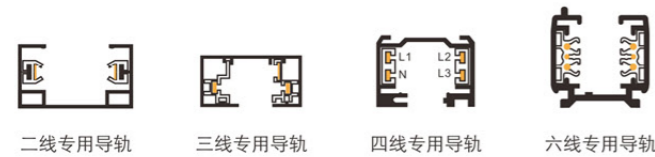

二线专用导轨 三线专用导轨 四线专用导轨 六线专用导轨

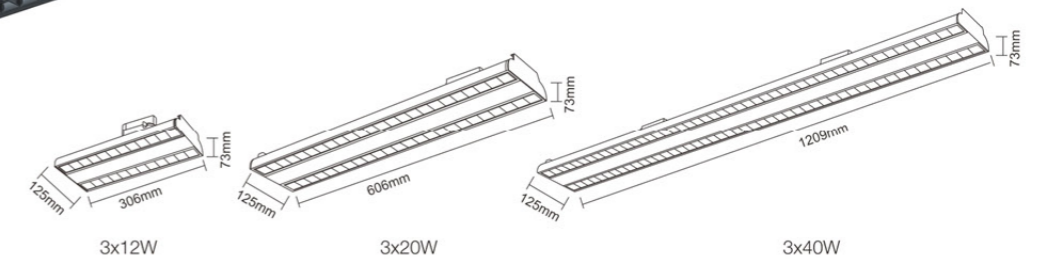

型号/Model	功率/Power	光源/light source	输入电压/Input voltage	显色指数/CRI	光通量/Luminous flux	材质/Material
LD-H03312	3x12W	SMD3030+2835	220-265V	Ra > 90	2700lm ± 10%lm	铝材/Aluminum
LD-H03320	3x20W	SMD3030+2835	220-265V	Ra > 90	4500lm ± 10%lm	铝材/Aluminum
LD-H03340	3x40W	SMD3030+2835	220-265V	Ra > 90	9000lm ± 10%lm	铝材/Aluminum

Light Source



Driver



色温/CCT 3000K 4000K 6000K  
颜色/Color 暖白/White 冷白/Black

专用轨道 Alternative dedicated track



二线专用导轨 三线专用导轨 四线专用导轨 六线专用导轨



039

040

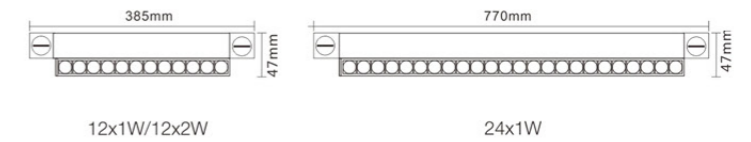
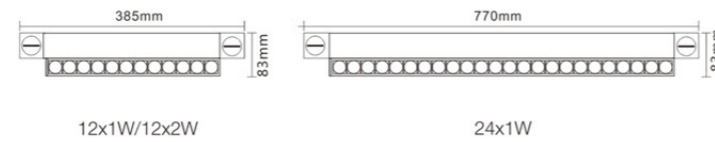

型号/Model	功率/Power	光源/light source	输入电压/Input voltage	显色指数/CRI	光通量/Luminous flux	材质/Material
LD-H04012	12x1W	SMD3030	220-265V	Ra > 90	1320lm ± 10%lm	铝材/Aluminum
LD-H04024	12x2W	SMD3030	220-265V	Ra > 90	2640lm ± 10%lm	铝材/Aluminum
LD-H04A24	24x1W	SMD3030	220-265V	Ra > 90	2640lm ± 10%lm	铝材/Aluminum

型号/Model	功率/Power	光源/light source	输入电压/Input voltage	显色指数/CRI	光通量/Luminous flux	材质/Material
LD-H05012	12x1W	SMD3030	220-265V	Ra > 90	1320lm ± 10%lm	铝材/Aluminum
LD-H05024	12x2W	SMD3030	220-265V	Ra > 90	2640lm ± 10%lm	铝材/Aluminum
LD-H05A24	24x1W	SMD3030	220-265V	Ra > 90	2640lm ± 10%lm	铝材/Aluminum

Light Source



色温/CCT 3000K 4000K 6000K  
颜色/Color 纯白/White 纯黑/Black

Driver



专用轨道 Alternative dedicated track



Light Source



色温/CCT 3000K 4000K 6000K  
颜色/Color 纯白/White 纯黑/Black

Driver



专用轨道 Alternative dedicated track



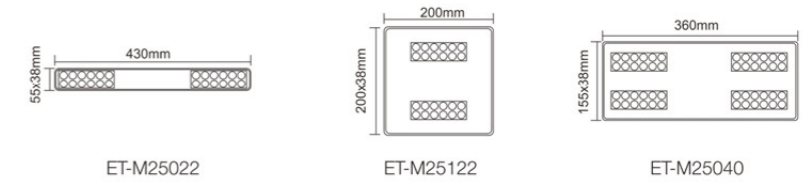

型号/Model	功率/Power	光源/light source	输入电压/Input voltage	显色指数/CRI	光通量/Luminous flux	材质/Material
LD-M25022	22W	SMD3030	220-265V	Ra>90	1870lm	铝材/Aluminum
LD-M25122	22W	SMD3030	220-265V	Ra>90	1870lm	铝材/Aluminum
LD-M25040	40W	SMD3030	220-265V	Ra>90	3400lm	铝材/Aluminum

## 38MM 超薄设计

Slim Design



重新定义 **薄** 概念

### Light Source

CREE, bridgelux, CITILED, CITIZEN, OSRAM

### Driver

EAGLERISE, LiFud, PHILIPS, TRIDONIC, OSRAM

色温/CCT: 3000K, 4000K, 6000K  
 颜色/Color: 纯白/White, 砂黑/Black



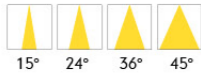
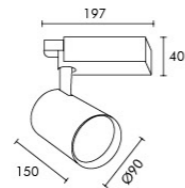

**LD90148-3D**

36W

3200Lm

**CCT**

3000K 4000K 5000K 5700K 6500K

**CRI**

Ra 80/90

光源优势对比：

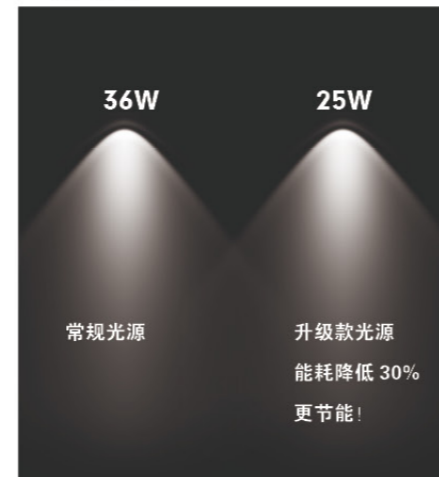

光源类型 Light Source: COB  
输入电压 Input Voltage: AC220V/50Hz  
材质 Maternal: 铝 Aluminum

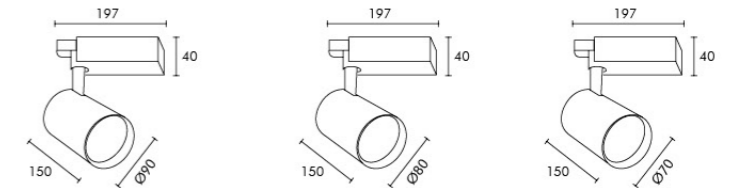
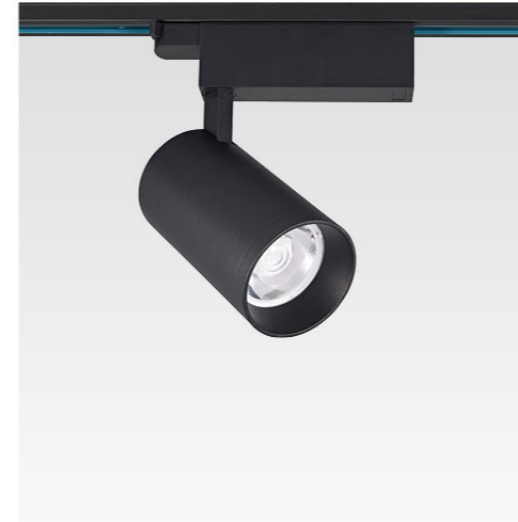

**LD90148-1D**

36W

3200Lm

**CCT**

3000K 4000K 5000K 5700K 6500K

**CRI**

Ra 80/90

**LD80148-1D**

30W

2600Lm

**LD70148-1D**

25W

2200Lm



光源类型 Light Source: COB  
输入电压 Input Voltage: AC220V/50Hz  
材质 Maternal: 铝 Aluminum



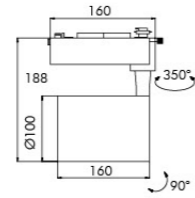

**LD90160-1**

25W

3200Lm

**CCT**

3000K 4000K 5000K 5700K 6500K

**CRI**

Ra 80/90

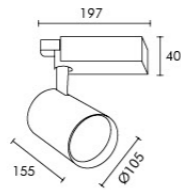
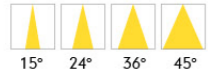

**LD-105155-1**

36W

3200Lm

**CCT**

3000K 4000K 5000K 5700K 6500K

**CRI**

Ra 80/90

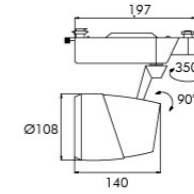
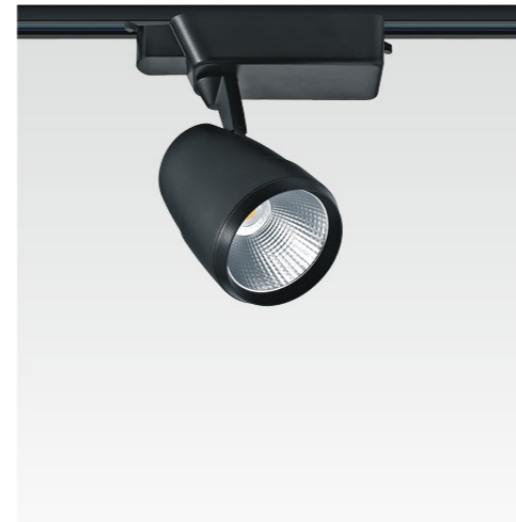
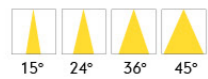

**LD108140-1**

36W

3200Lm

**CCT**

3000K 4000K 5000K 5700K 6500K

**CRI**

Ra 80/90

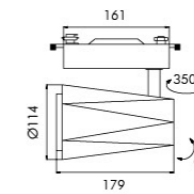

**LD115180-1**

36W

3200Lm

**CCT**

3000K 4000K 5000K 5700K 6500K

**CRI**

Ra 80/90



045

046

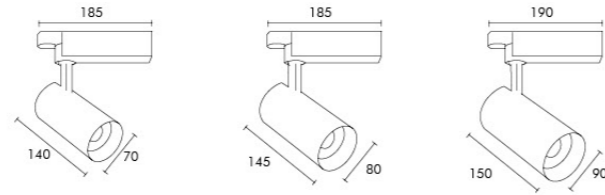

**LD-GD7020-1**

20W

1750Lm

**LD-GD8030-1**

30W

2600Lm

**LD-GD9035-1**

36W

3200Lm

**CCT**

3000K 4000K 5000K 5700K 6500K

**CRI**

Ra 80/90

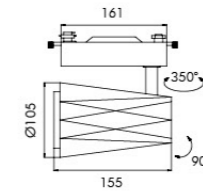
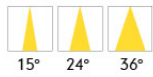

**LD-T10150**

25W

3200Lm

**CCT**

3000K 4000K 5000K 5700K 6500K

**CRI**

Ra 80/90

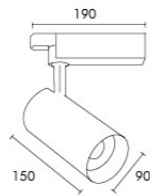
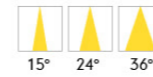

**LD-GD9035-3**

25W

3200Lm

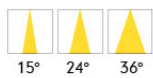
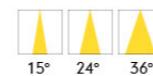

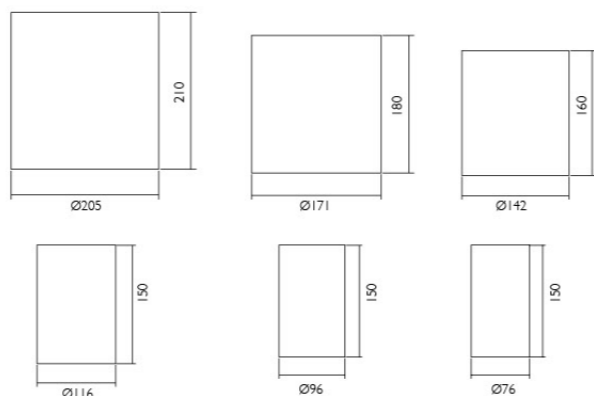

<b>LD-A205210</b> 80W 6400Lm	<b>LD-A171180</b> 50W 4000Lm	<b>LD-A142160</b> 36W 2800Lm
------------------------------------	------------------------------------	------------------------------------

<b>LD-A116150</b> 25W 2000Lm	<b>LD-A96150</b> 20W 1600Lm	<b>LD-A76150</b> 15W 1200Lm
------------------------------------	-----------------------------------	-----------------------------------

**CCT**  
3000K 4000K 5000K 5700K 6500K

**CRI**  
Ra 80/90



光源类型 Light Source: COB  
输入电压 Input Voltage: AC220V/50Hz  
材质 Maternal: 铝 Aluminum

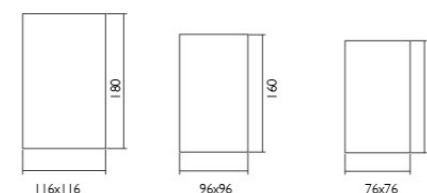

<b>LD-A116180F</b> 30W 2400Lm	<b>LD-A96160F</b> 25W 2000Lm	<b>LD-A76150F</b> 18W 1400Lm
-------------------------------------	------------------------------------	------------------------------------

**CCT**  
3000K 4000K 5000K 5700K 6500K

**CRI**  
Ra 80/90



光源类型 Light Source: COB  
输入电压 Input Voltage: AC220V/50Hz  
材质 Maternal: 铝 Aluminum



049

050

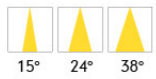
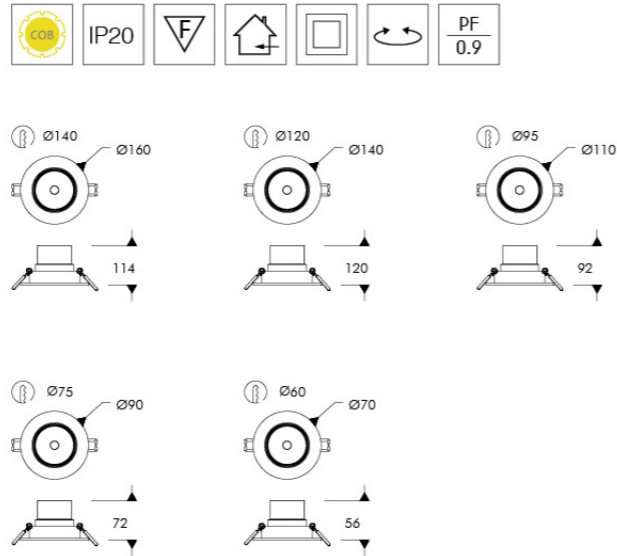

**CCT**  
3000K 4000K 5000K 5700K 6500K

**CRI**  
Ra 80/90



光源类型 Light Source: COB  
输入电压 Input Voltage: AC220V/50Hz  
材质 Maternal: 铝 Aluminum

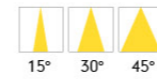
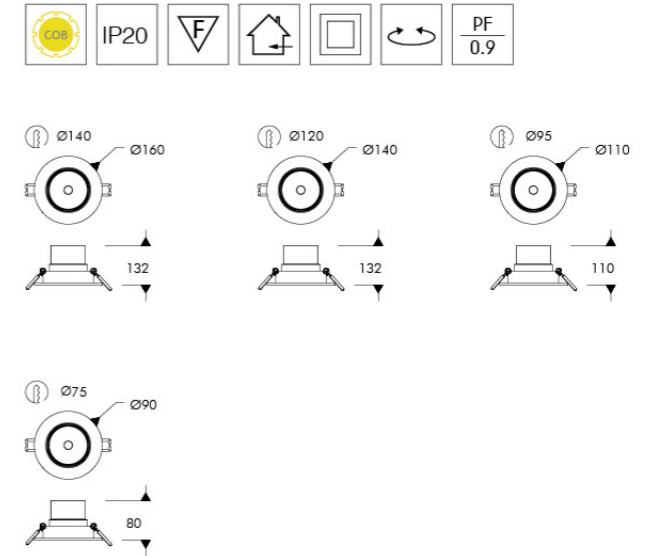

**CCT**  
3000K 4000K 5000K 5700K 6500K

**CRI**  
Ra 80/90



光源类型 Light Source: COB  
输入电压 Input Voltage: AC220V/50Hz  
材质 Maternal: 铝 Aluminum



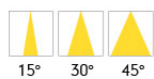
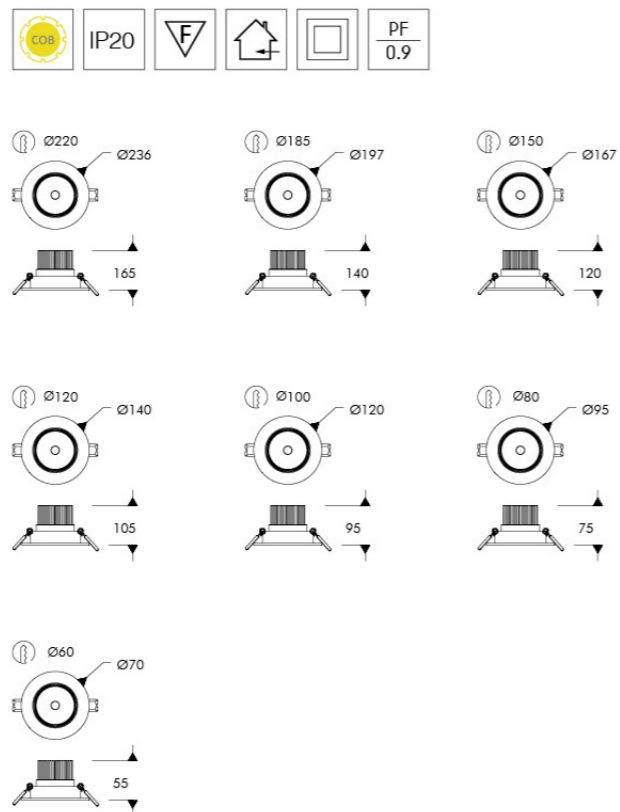

**CCT**  
3000K 4000K 5000K 5700K 6500K

**CRI**  
Ra 80/90



光源类型 Light Source: COB  
输入电压 Input Voltage: AC220V/50Hz  
材质 Maternal: 铝 Aluminum

<b>LD-B236165</b> 80W 6400Lm	<b>LD-B197140</b> 60W 4800Lm	<b>LD-B167120</b> 36W 2800Lm
<b>LD-B140105</b> 30W 2400Lm	<b>LD-B12095</b> 20W 1600Lm	<b>LD-B9575</b> 15W 1200Lm
<b>LD-B7055</b> 9W 720Lm		

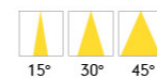
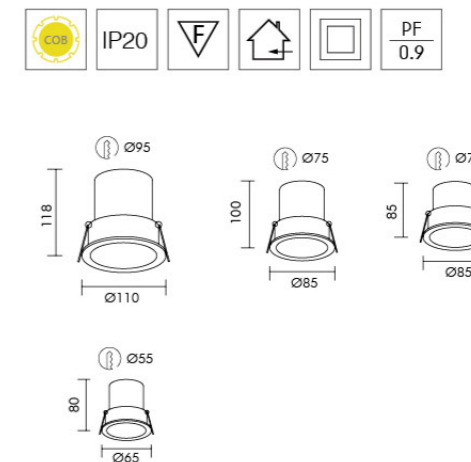

**CCT**  
3000K 4000K 5000K 5700K 6500K

**CRI**  
Ra 80/90



光源类型 Light Source: COB  
输入电压 Input Voltage: AC220V/50Hz  
材质 Maternal: 铝 Aluminum

<b>LD-B110118</b> 20W 1800Lm	<b>LD-B85100</b> 15W 1350Lm	<b>LD-B8585</b> 12W 1050Lm
<b>LD-B6580</b> 7W 600Lm		



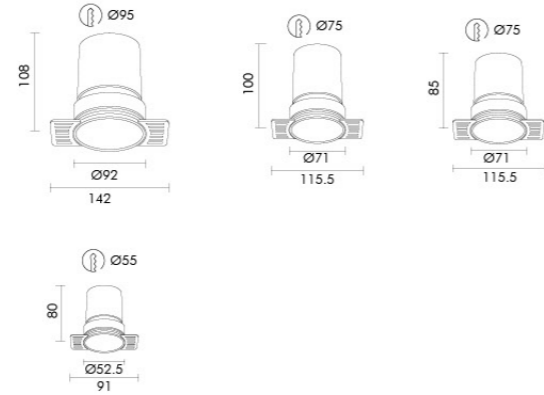

**CCT**  
3000K 4000K 5000K 5700K 6500K

**CRI**  
Ra 80/90



光源类型 Light Source: COB  
输入电压 Input Voltage: AC220V/50Hz  
材质 Maternal: 铝 Aluminum

<b>LD-B142108C</b>	<b>LD-B115100C</b>	<b>LD-B11585C</b>
20W	15W	12W
1800Lm	1350Lm	1080Lm

**LD-B9180C**  
8W  
720Lm

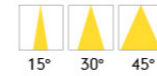
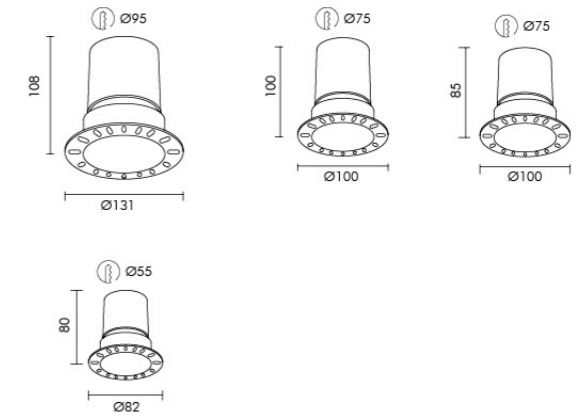

**CCT**  
3000K 4000K 5000K 5700K 6500K

**CRI**  
Ra 80/90



光源类型 Light Source: COB  
输入电压 Input Voltage: AC220V/50Hz  
材质 Maternal: 铝 Aluminum

<b>LD-B131108B</b>	<b>LD-B100100B</b>	<b>LD-B10085B</b>
20W	15W	12W
1800Lm	1350Lm	1080Lm

**LD-B8280B**  
8W  
720Lm



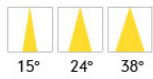
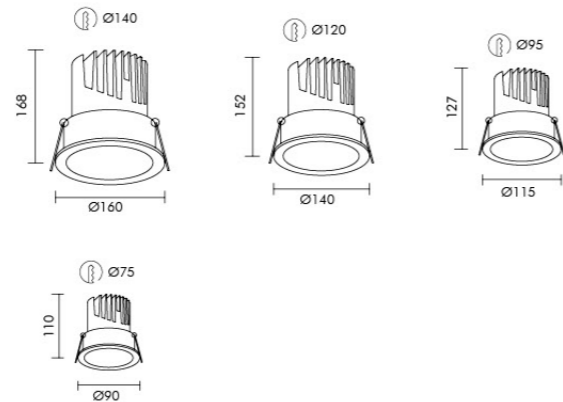

**CCT**  
3000K 4000K 5000K 5700K 6500K

**CRI**  
Ra 80/90



光源类型 Light Source: COB  
输入电压 Input Voltage: AC220V/50Hz  
材质 Maternal: 铝 Aluminum



光源类型 Light Source: COB  
输入电压 Input Voltage: AC220V/50Hz  
材质 Maternal: 铝 Aluminum

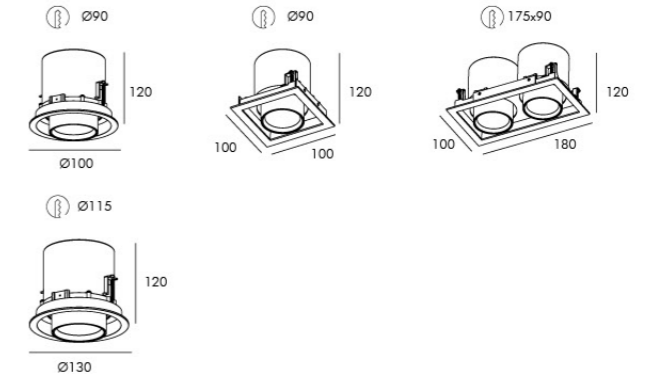

<b>LD-DX-15A</b> 15W 1200Lm	<b>LD-DX-15B</b> 15W 1200Lm	<b>LD-DX-215B</b> 2x15W 2400Lm
-----------------------------------	-----------------------------------	--------------------------------------

**LD-DX-25A**  
25W  
2000Lm

**CCT**  
3000K 4000K 5000K 5700K 6500K

**CRI**  
Ra 80/90



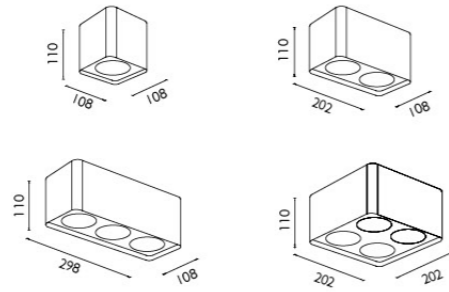
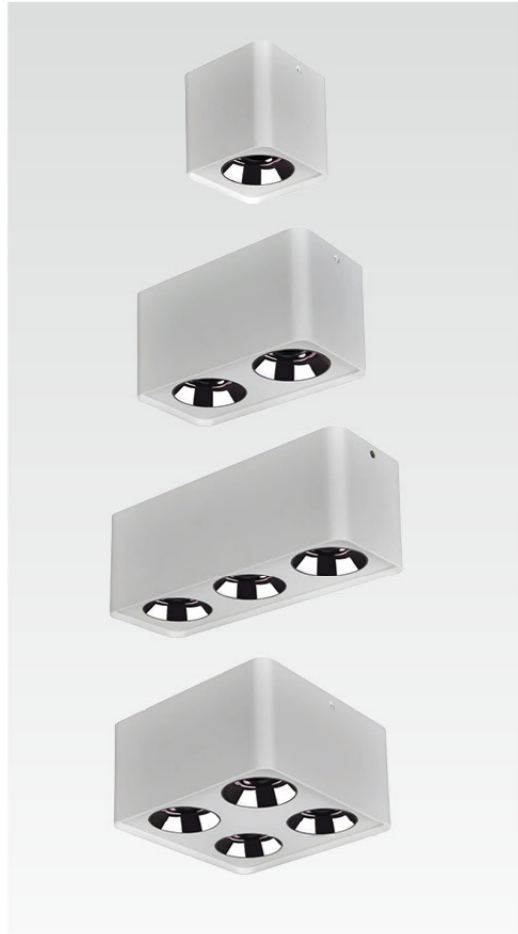

**LD-A101011**

12W

950Lm

**LD-A201011**

2x12W

1900Lm

**LD-A301011**

3x12W

2850Lm

**LD-A202011**

4x12W

3800Lm



**LD-DJ08-10**

12W

950Lm



**LD-DJ08-20**

2x12W

1900Lm



**LD-DJ08-30**

3x12W

2850Lm



**LD-DJ08-40**

4x12W

3800Lm

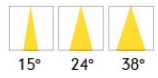

**CCT**

3000K 4000K 5000K 5700K 6500K

**CRI**

Ra 80/90



光源类型 Light Source: COB  
输入电压 Input Voltage: AC220V/50Hz  
材质 Maternal: 铝 Aluminum

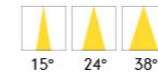

**CCT**

3000K 4000K 5000K 5700K 6500K

**CRI**

Ra 80/90



光源类型 Light Source: COB  
输入电压 Input Voltage: AC220V/50Hz  
材质 Maternal: 铝 Aluminum



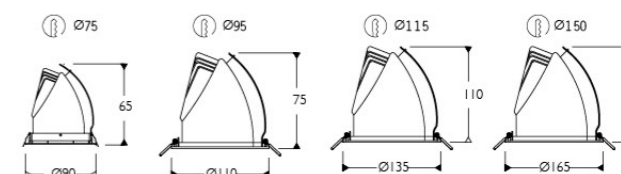

**LD-B9065**

12W

950Lm

**LD-B11075**

20W

1600Lm

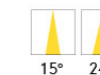

**LD-B135110**

30W

2400Lm

**LD-B165120**

40W

3200Lm

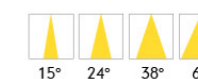

**CCT**

3000K 4000K 5000K 5700K 6500K

**CRI**

Ra 80/90



光源类型 Light Source: COB  
 输入电压 Input Voltage: AC220V/50Hz  
 材质 Maternal: 铝 Aluminum



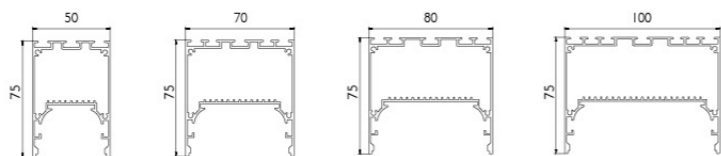
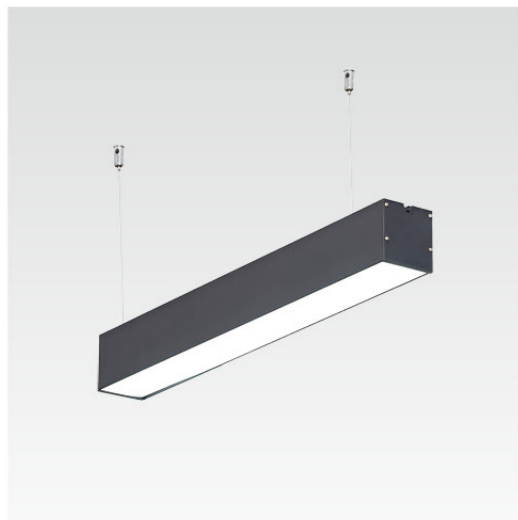

<b>LD-50751200</b>	<b>LD-70751200</b>	<b>LD-80751200</b>
30W	40W	40W
2100Lm	2800Lm	2800Lm

<b>LD-100751200</b>
40W
2800Lm



110°

**CCT**

3000K 4000K 5000K 6500K

**CRI**

Ra 80



光源类型 Light Source: SMD  
输入电压 Input Voltage: AC220V/50Hz  
材质 Maternal: 铝 Aluminum

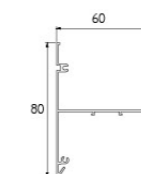
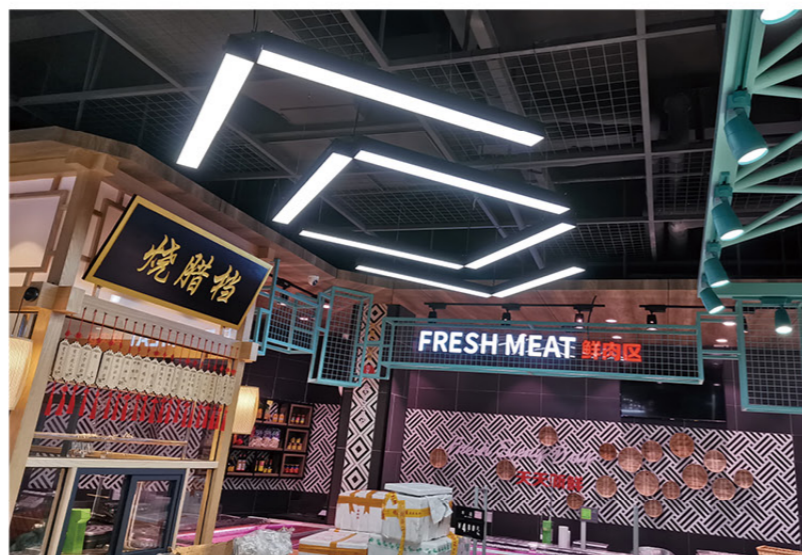

<b>LD-80601200</b>	<b>LD-80601500</b>
40W	48W
3000Lm	3600Lm



110°

**CCT**

3000K 4000K 5000K 6500K

**CRI**

Ra 80



光源类型 Light Source: SMD  
输入电压 Input Voltage: AC220V/50Hz  
材质 Maternal: 铝 Aluminum



063

064



LED 线条灯  
LED LINE LIGHT

模块组合  
Module combination

065



LD150851200



光带模块



LD150851400



射灯模块



LD150851600

平板灯模块与射灯模块组合

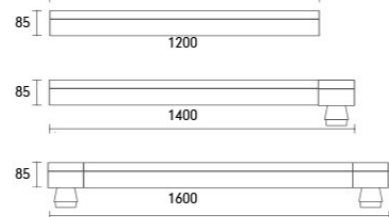

LD150851200

40W

3200Lm

- ◆ 可选色温: 3000K、4000K、5000K、6000K
- ◆ 可选颜色: 黑色、灰色、白色
- ◆ 显色指数: CRI ≥ 80
- ◆ 输入电压: 220-240V 50-60Hz
- ◆ 材质: 铝型材 + 亚克力



▲ 120°

066



LD-15085A

36W

3200Lm

- ◆ 可选色温: 3000K、4000K、5000K、6000K
- ◆ 可选颜色: 黑色、灰色、白色
- ◆ 显色指数: CRI ≥ 80
- ◆ 输入电压: 220-240V 50-60Hz
- ◆ 材质: 铝合金



▲ 24° / 36°

照明应用  
Lighting application

独立模块，自由组合

中间平板主要是基础照明作用；两端射灯作重点照明，突出重点区域，强化空间的明暗对比

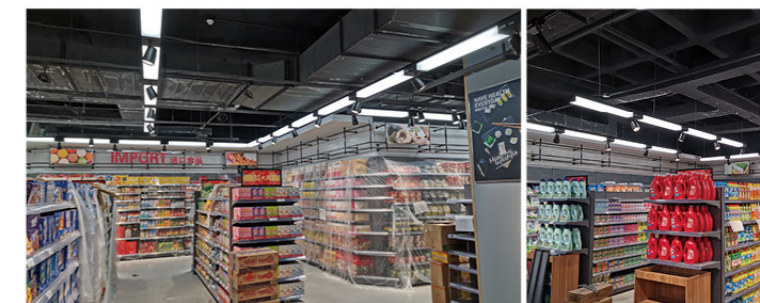
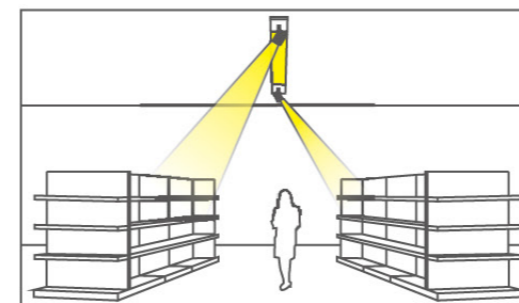



嵌入式货架硬灯条

产品型号	电压	功率	色温	光通量	显指 Ra	发光角度	颜色	外形尺寸
LD-24D-1100	24V AC/DC	9W	3000/4000/5000/6500K	680lm	80	120	铝色	19*10*1100mm
LD-24D-1000	24V AC/DC	8W	3000/4000/5000/6500K	600lm	80	120	铝色	19*10*1000mm
LD-24D-900	24V AC/DC	7W	3000/4000/5000/6500K	530lm	80	120	铝色	19*10*900mm
LD-24D-800	24V AC/DC	6W	3000/4000/5000/6500K	450lm	80	120	铝色	19*10*800mm
LD-24D-700	24V AC/DC	5.5W	3000/4000/5000/6500K	380lm	80	120	铝色	19*10*700mm
LD-24D-600	24V AC/DC	4.5W	3000/4000/5000/6500K	330lm	80	120	铝色	19*10*600mm
LD-24D-500	24V AC/DC	4W	3000/4000/5000/6500K	300lm	80	120	铝色	19*10*500mm
LD-24D-450	24V AC/DC	3.5W	3000/4000/5000/6500K	260lm	80	120	铝色	19*10*450mm
LD-24D-400	24V AC/DC	3W	3000/4000/5000/6500K	230lm	80	120	铝色	19*10*400mm
LD-24D-350	24V AC/DC	2.5W	3000/4000/5000/6500K	190lm	80	120	铝色	19*10*350mm
LD-24D-300	24V AC/DC	2W	3000/4000/5000/6500K	150lm	80	120	铝色	19*10*300mm

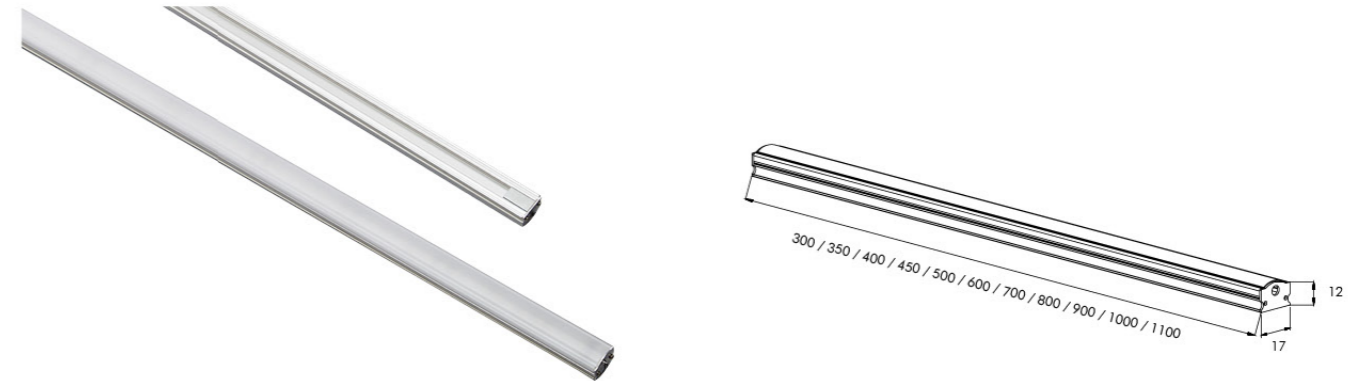

磁吸式货架硬灯条

产品型号	电压	功率	色温	光通量	显指 Ra	发光角度	颜色	外形尺寸
LD-24C-1100	24V AC/DC	9W	3000/4000/5000/6500K	770lm	80	120	铝色	17*12*1100mm
LD-24C-1000	24V AC/DC	8W	3000/4000/5000/6500K	680lm	80	120	铝色	17*12*1000mm
LD-24C-900	24V AC/DC	7W	3000/4000/5000/6500K	600lm	80	120	铝色	17*12*900mm
LD-24C-800	24V AC/DC	6W	3000/4000/5000/6500K	510lm	80	120	铝色	17*12*800mm
LD-24C-700	24V AC/DC	5.5W	3000/4000/5000/6500K	470lm	80	120	铝色	17*12*700mm
LD-24C-600	24V AC/DC	4.5W	3000/4000/5000/6500K	380lm	80	120	铝色	17*12*600mm
LD-24C-500	24V AC/DC	4W	3000/4000/5000/6500K	340lm	80	120	铝色	17*12*500mm
LD-24C-450	24V AC/DC	3.5W	3000/4000/5000/6500K	300lm	80	120	铝色	17*12*450mm
LD-24C-400	24V AC/DC	3W	3000/4000/5000/6500K	260lm	80	120	铝色	17*12*400mm
LD-24C-350	24V AC/DC	2.5W	3000/4000/5000/6500K	210lm	80	120	铝色	17*12*350mm
LD-24C-300	24V AC/DC	2W	3000/4000/5000/6500K	170lm	80	120	铝色	17*12*300mm

